



BUILDING PLASTICS

WINDOW & DOOR SOLUTIONS



2021



**EXCLUSIVE
TRADE DEALS
AVAILABLE**

**ASK IN BRANCH
FOR DETAILS**

aspect®

charisma

syncro

the dales
collection

logik™

logik ™

modus®

modus® 

WINDOWS, DOORS & HARDWARE

PRODUCT RANGE

WINDOW RANGE	04
MODUS WINDOWS	06
LOGIK WINDOWS	10
CHARISMA VERTICAL SLIDERS	16
WINDOW FINISHINGS	18
ROOFLIGHTS	38
DOORS	44
DALES COMPOSITE DOORS	46
ELEGANCE PVC-U DOORS	54
SYNCRO SLIDING PATIO DOORS	61
ASPECT PVC-U BI-FOLD DOORS	64
STUDIOGLIDE ALUMINIUM BI-FOLD DOORS	66
LOGIK FRENCH DOORS	68
GARAGE DOORS	74
HARDWARE	76



HARWARE

76



**OVER 6000
PRODUCTS
IN-BRANCH**



**200+ BRANCHES
NATIONWIDE**



**PRODUCT EXPERTS
IN EVERY BRANCH**



**FREE SURVEYS
& QUOTATIONS**



**CLICK & COLLECT
IN-BRANCH**



**FREE ONSITE
DELIVERY***

*Longer lead times apply to made-to-order items. Applies to mainland UK only and excludes Northern Ireland & Northern Scotland. Minimum order value of £50.



DOORS

44



GARAGE DOORS

74



BI-FOLD AND PATIO DOORS

61



WINDOW RANGE

04



BUILDING PLASTICS

WINDOWS

EUROCELL WINDOWS & DOORS

FROM EUROCELL BRANCHES



POWERED BY



GET INSTANT QUOTES

Visit your local branch today to get quotes in an instant on a full range of windows and doors.

**READY TO COLLECT IN-BRANCH
IN JUST 7-14 WORKING DAYS**

IT'S A NO BRAINER!



SAVE TIME & MONEY

When you're buying Eurocell roofline products from your local branch, make sure you pick up your windows too! Whether you're looking for traditional casement windows, fully-engineered vertical sliding sash windows or our advanced tilt and turn windows, they're all in one place – saving you time and money!



MARKET LEADING WINDOWS – IN-BRANCH NOW!

You'll find outstanding performance right across the range. With a choice of styles, colours and finishes to suit building, our innovative windows boast A++ energy ratings and U-values as low as 0.8. In other words, they exceed the latest energy-efficiency standards.



FULLY GUARANTEED

Windows bought from your local branch are covered by a 10 year guarantee.



**FIND YOUR LOCAL BRANCH AT
eurocell.co.uk/branchfinder**

modus®

A breakthrough in design, engineering & performance

At a glance:

- ✓ Clean and contemporary looks with slimmer sight lines – different to traditional PVC-U windows.
- ✓ Advanced engineering technology – achieves the new A++ Window Energy Rating and a 0.7 U-value.
- ✓ Sustainability as standard – manufactured using 50% recycled material.
- ✓ Cost-effective alternative to aluminium.

A++

Superb
energy efficiency
performance

U0.7

U-value as low as
0.7 for improved
performance



Advanced
profile design

12
YEAR

Industry leading
12-year
guarantee

INNOVATION. INSPIRATION

Secured by Design



Official Police Security Initiative



PAS 24

Enhanced security performance for doorsets & windows in the UK

MODUS WINDOWS

modus®

A COMPLETE RANGE OF WINDOWS & DOORS:

- Standard sash casement windows
- Slim rebate sash casement windows
- Flush sash casement windows
- Reversible windows
- Tilt & turn windows
- Entrance doors
- French doors

AVAILABLE IN 3 SASH STYLES:



Standard sash



Slim rebate sash



Fully flush sash

INNOVATION. INSPIRATION



COLOUR OPTIONS



WHITE



WHITE ASH

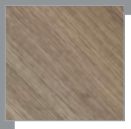

ANTEAK*



AGATE GREY

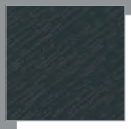

ANTHRACITE
GREY



SLATE GREY



MOONDUST
GREY

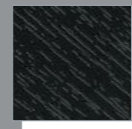

BLACK ASH
GREY



IRISH OAK



CREAM
WHITE

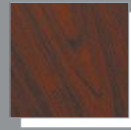

ROSEWOOD

* on flush sash & slim sash only

logik **S**TM

Flush Sash Windows

LEVEL BEST FOR STYLE & PERFORMANCE

The Logik range just got one better with the **NEW** Logik S Flush Sash. Sleek and streamlined enough to suit any ultra-modern new build project – or to bring older properties bang up to date – and as easy fitting, energy efficient and secure as the rest of the Logik range.

The Flush Sash also features a grey substrate option that means no white core is visible, even with the window open. A genuine alternative to the premium look of aluminium without the price tag.

You could say it's taken
Logik quality, efficiency and
performance to a
whole new level.

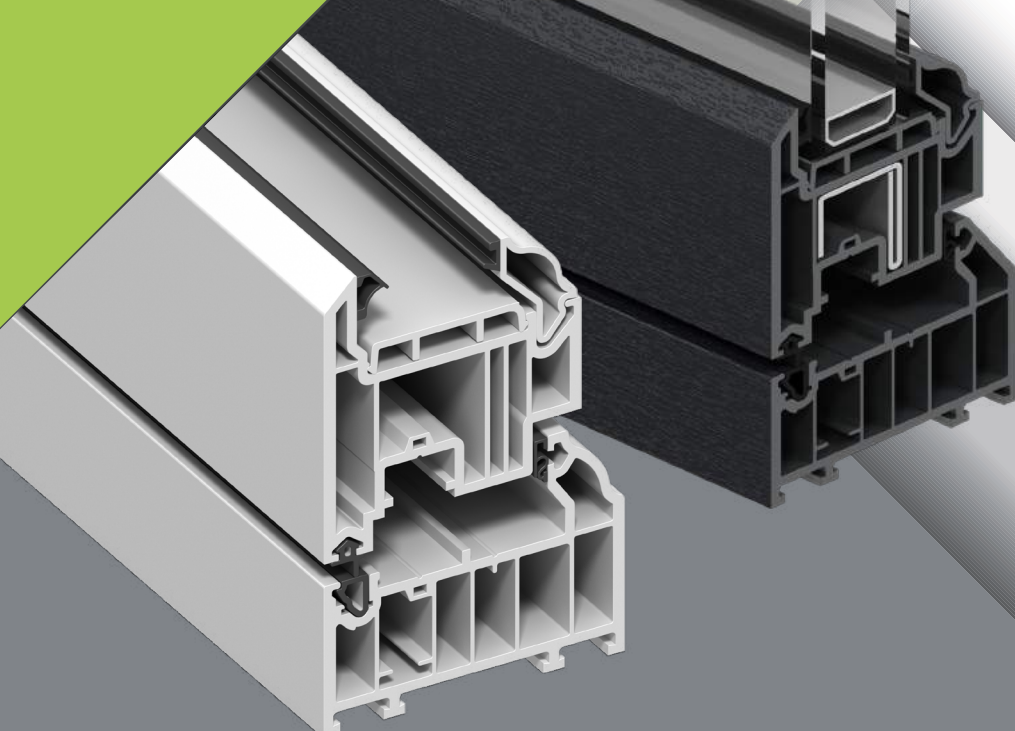



Compatible with full Logik range



Wide range of colour and style options



Superb energy efficiency performance



U-values as low as 0.8



Fast, accurate fabrication & installation



Tested to BS 6375 & PAS24



Market-leading sustainability



10-year guarantee for peace of mind

A perfect addition to the range

And like the rest of the Logik range, an extensive choice of woodgrain foils gives Logik S Flush Sash a real wood look that stands up to all but the closest of inspections. Or in grey delivers an architectural design feel. Its the perfect replacement window for adding contemporary kerb appeal to older homes or retaining character in older properties.



LOGIK WINDOWS

The logo for Logik Windows, featuring the word "logik" in a lowercase, sans-serif font with a registered trademark symbol (®) to the upper right. The logo is set against a solid green rectangular background.A photograph of a modern, two-story house with a mix of white and light wood cladding. The house features several windows with dark frames, including a large bay window on the ground floor and a smaller window on the upper floor. The house is set against a cloudy sky.

The leading high-performance, sustainable window system



BBA certified system



Market-leading sustainability



Wide range of colour and style options



10-year guarantee for peace of mind



Made & recycled in the UK

3 SASH STYLES IN 1 SYSTEM



Outstanding
technical performance



Fast, accurate
fabrication and
installation

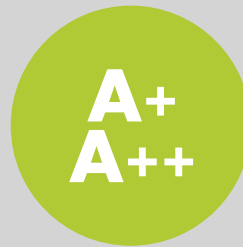

Superb energy
efficiency performance

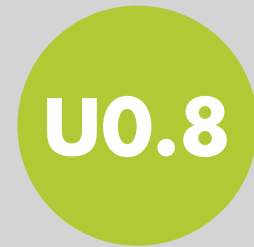

U-values as
low as 0.8

COLOUR OPTIONS



WHITE



CREAM



CREAM
WHITE



WHITE ASH*



AGATE GREY



ANTHRACITE
GREY

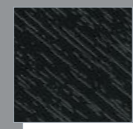

BLACK ASH



IRISH OAK*



GOLDEN OAK*

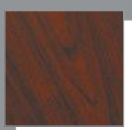

ROSEWOOD*



CHARTWELL
GREEN



OLIVE GREEN

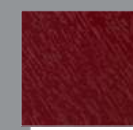

DARK RED

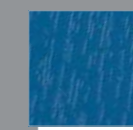

BLUE

* matching internal foil colour available

A GREY REVOLUTION - LOGIK S

The outstanding feature that makes Logik so special, though, is its grey substrate option.

With a through-colour grey frame instead of just a surface foil, there's no sign of a white PVC-U core, even when you open the window.

It may seem like a small detail, but the all-grey look is a big thing with homeowners right now and many people are more than ready to pay a premium for it in PVC-U rather than choose the much more expensive aluminium option.

So make sure you're ready to supply everything they're looking for with new Logik S Flush Sash to complement the Logik chamfered and Ovolo options.



GREY SUBSTRATE OPTION FOR THE CONSISTENT LOOK

Also available on Aspect panoramic doors and the new Syncro sliding patio door at launch.

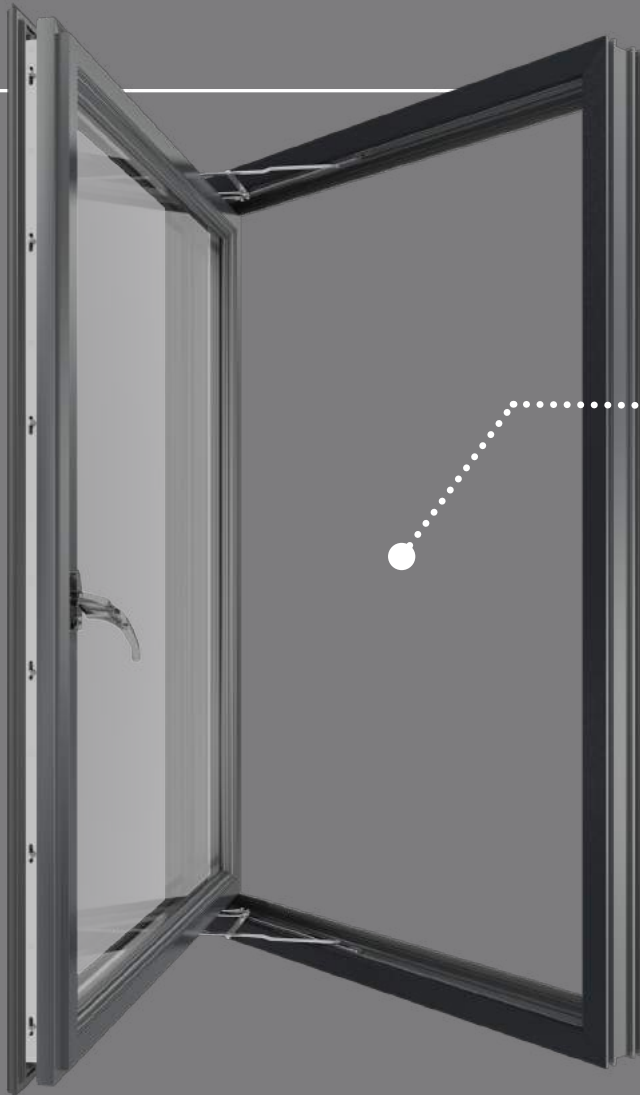
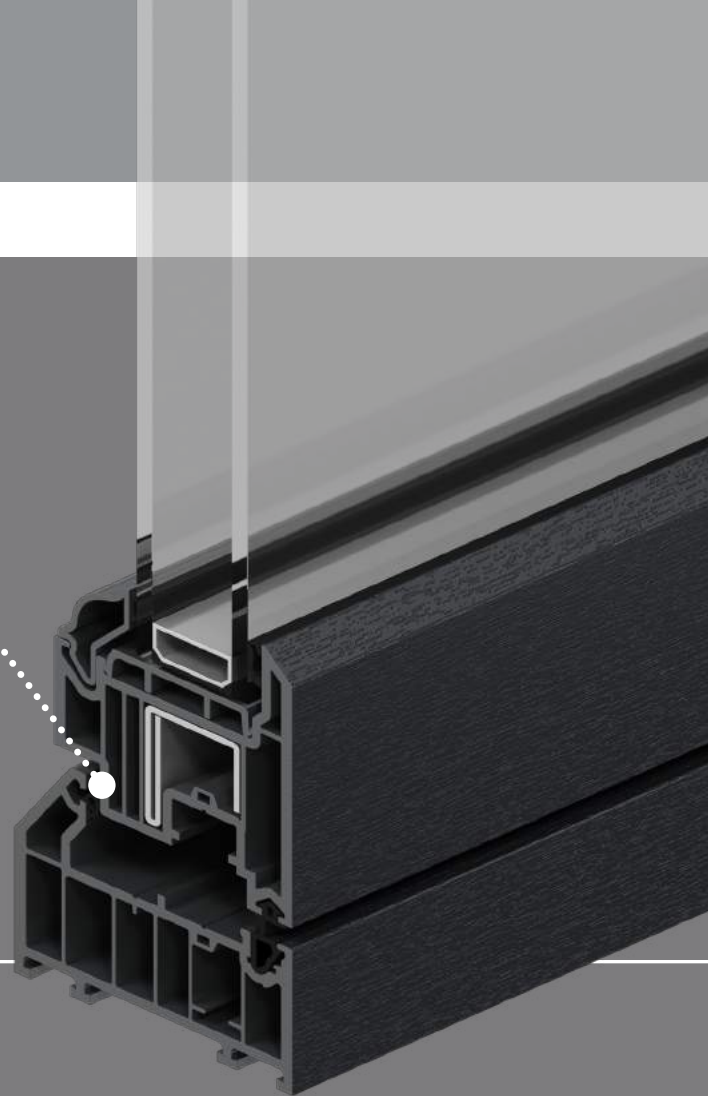

THE CONSISTENT LOOK
Even with the window open

AVAILABLE ON:

Logik windows and doors

Aspect Panoramic Doors

Syncro Sliding Patio Doors (COMING SOON)

VERTICAL SLIDING WINDOWS

charisma

The ultimate combination of classic design and 21st century engineering

A+

Superb energy efficiency performance

U1.3

U-values as low as 1.3



Outstanding technical performance

**10
YEAR**

U-value as low as 1.3





Heritage
specification
available



BBA certified
system



Wide range
of colour and
style options



10-year
guarantee for
peace of mind



COLOUR OPTIONS



WHITE



CARAMEL



BROWN



CREAM
WHITE

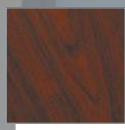

ROSEWOOD



CREAM
WHITE

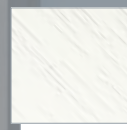

WHITE ASH



ROSEWOOD

WINDOW FINISHING

CONTENTS

Cavity closers	20
Overhead vent	24
Glass & bridge packers	24
Window cills & accessories	26
Cill repair covers	28
Bow window accessories	29
Window boards	30
Finishing trims	34
Cosmetic repairs	37

From cavity closers to trims to window boards, our window finishing range allows you to get the perfect finish – for every job!

- **Cavity closers**

Close cavities quickly and effectively with our range of Cavalok closers, whilst improving thermal efficiency for homeowners - find out more on page 20

- **Intelligent 150mm cill**

The 150mm cill system has the flexibility to create larger sizes (up to 225mm) and accommodate project tolerance discrepancies through the use of various trims - find out more on page 26

- **Laminated window boards**

These scratch-resistant boards add the finishing touch to your window installation - find out more on page 30

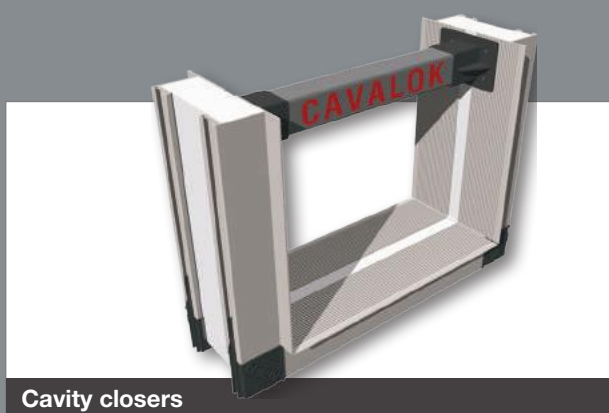

Cavity closers



Intelligent cills



Laminated window boards

WHAT IS A CAVITY CLOSER?

cavity closer

A cavity closer is an energy-efficient aperture former which enables brick courses to be completed and creates an Air-tight receiver for windows and doors

BENEFITS

- Provides a damp proof course
- Simplifies brickwork - no return bricks needed
- Provides thermal break
- Stops cold bridging which can cause condensation to form inside the opening damaging internal decoration and plasterwork
- Improves heat loss at the window junction, reducing CO₂ emissions
- Meets Accredited Construction Details regulation designed to improve the heat loss at junctions
- Meets needs of Part L of the Building Regulations



Cavalok products are made from **100% recycled PVC-U**

NEED MORE INFORMATION?



Our comprehensive **Specification Guide** includes dimensions and examples of use, along with detailed information on the rest of Eurocell's product offering.

For more information call our customer services team **0800 988 3074** or download from our website today at eurocell.co.uk/ebpspecguide

WHICH PRODUCT IS RIGHT FOR YOU?

CAVALOK UNIVERSAL CAVITY CLOSER

- For cavity sizes 50-100mm
- Use for new build projects
- Cavity closer is assembled into a window template
- Ensures window manufacturer can produce to correct sizes without repeated surveying - saving time and money by reducing rework or snagging
- Easy to install, use with standard plastic ties to fix into coursework as you build

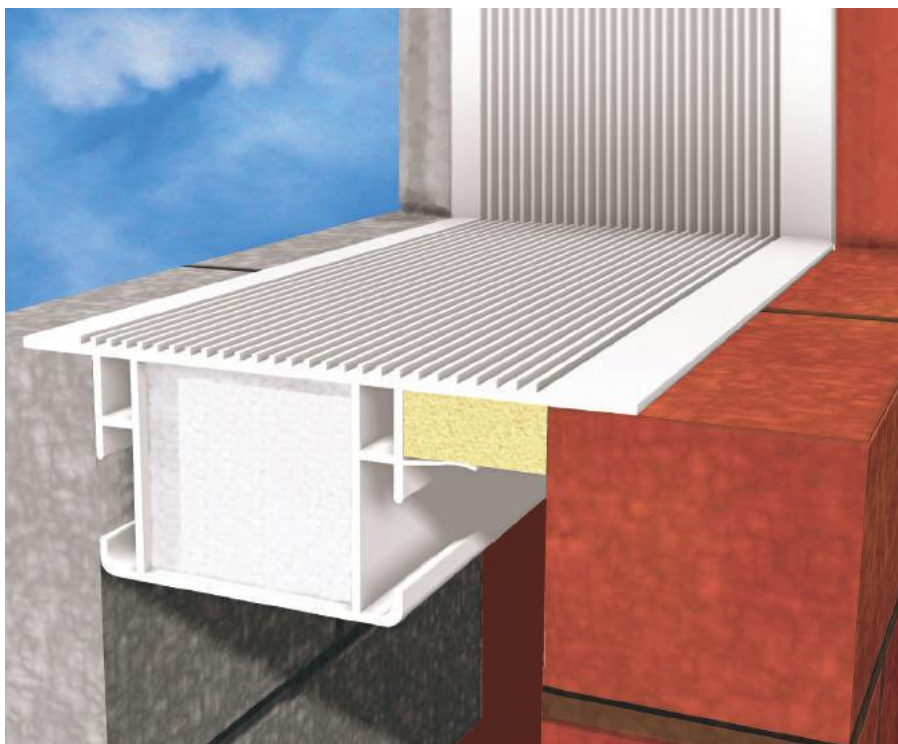

CAVALOK BIG BLOK CAVITY CLOSER

- For cavity sizes 125-300mm
- Use for new build projects
- Cavity closer is assembled into a window template
- Super-insulating, specially designed to meet the Code for Sustainable Homes
- Easy to install, use with standard plastic ties to fix into coursework as you build



*MTO - Max 150mm from stock.

CAVITY CLOSER



LOOKING FOR FABRICATED CAVITY CLOSERS? CALL US NOW 0800 988 3047

IDEAL FOR REFURBISHMENT PROJECTS

Slotted design allows you to cut down the product to fit your cavity width

Just one product to hold in stock or in the van, no assembly required

Punched flange for easy fixing

Easy way to improve the damp proof course when replacing a window

FOR CAVITY SIZES 50 - 100mm



FRAME FORMING CORNERS

Cavalok corners

50mm	
Code	Qty
CBP CAV 50 MOU	100/box
75mm, 90mm, 100mm	
Code	Qty
CBP CAV 75 MOU 13	100/box

Big Blok corners

For use on all 125mm - 300mm cavity closers

Code	Qty
CBP BB MOU	200/box

Big Blok corner fillet

1.2m lengths

For use on all 125mm - 300mm cavity closers

Code	Qty
CBP BBS FIL	50 pack

CAVITY CLOSER SECTIONS

Trade closer



- This is a stand alone product - no extra components or assembly required!
- Suitable for applications between 50mm and 100mm

Code	Qty
MCBP TDR 100 HOR	10 pack

Window fixing strap

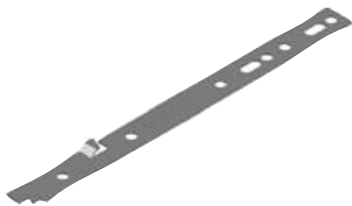

Code	Qty
CBPSTF7U2E	250 pack

Big Blok closer



125mm closer (insulated)

Code	Size
MCBP 125 HOR 48	4 x 4.8m

150mm closer (insulated)

Code	Qty
MCBP 150 HOR 48	4 pack

Universal closer

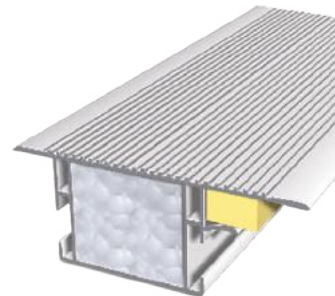

125mm closer (insulated)

Code	Qty
MCBP 050 HOR 48	6 pack

75mm closer (insulated)

Code	Qty
MCBP 075 HOR 48	6 pack

100mm closer (insulated)

Code	Qty
MCBP 100 HOR 48	6 pack

FRAME FORMING BRACING

Brace bar

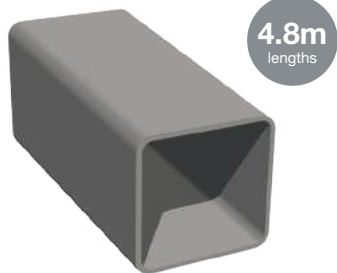

For use with both Cavalok and Big Blok closer

Code	Qty
MCBP CAV BR BOX	60 pack

Brace boot



For use with both Cavalok and Big Blok closer

Code	Qty
CBP BOOT 14	100/box

FRAME INSTALLATION

Brick ties



For use with both Cavalok and Big Blok closer

Code	Qty
CBP BB TIE	1000/box

OVERHEAD VENT

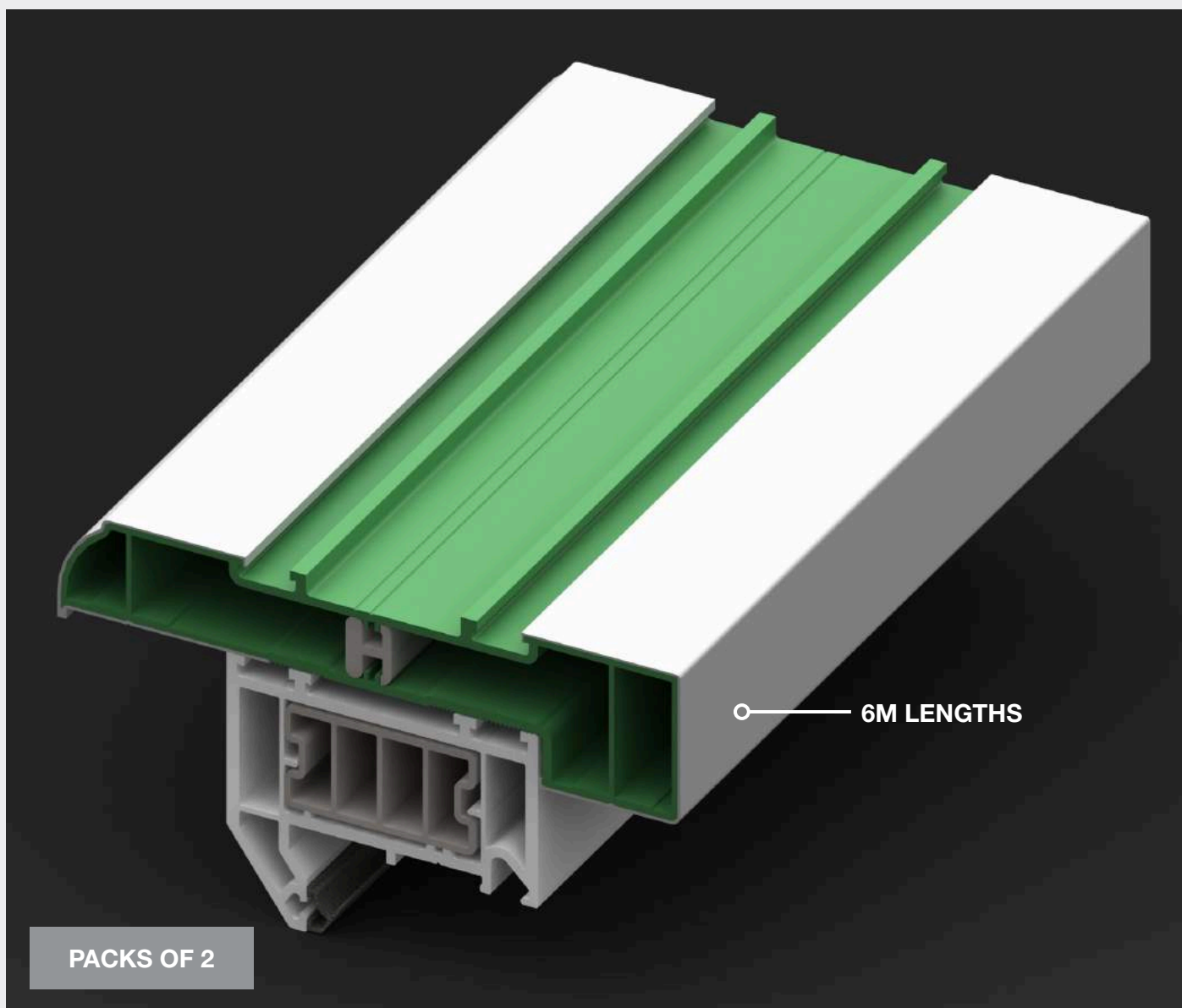

Universal head vent

Code	Foil	Stock/MTO
EWS137W	N/A	STOCK
EWS137WGY1LF	Antrachite Grey LF	STOCK
EWS137WGY2SLF	Smooth Slate Grey LF	STOCK
EWS137WROLF	Rosewood LF	MTO
EWS137WOLF	Golden Oak LF	MTO
EWS137WGY2LF	Slate Grey LF	MTO
EWS137WGY1SLF	Smooth Antrachite Grey LF	MTO
EWS137WYLF	Black Ash LF	MTO
EWS137WT1LF	Chartwell Green LF	MTO
EWS137WCR1LF	Cream White LF	MTO
EWS137WZBF	White Ash BF	MTO

Designed to be used with frames with a front to back dimension of up to 80mm.

On the inside the vent has a square box detail which allows the head of the reveal to be double boarded without obstructing the ventilation path.

Head vent spacer

Code	Foil	Qty
VSW105W	N/A	Pack of 50

TRICKLE VENTILATION

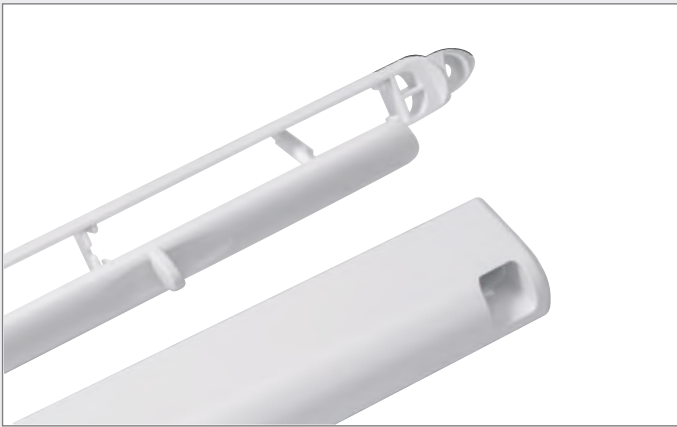

Trim vent and canopy

Code	Size	Qty
TS VENT	XS 4400 EA ventilator (screw fix)	50 pack

COLOUR OPTIONS

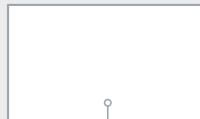

WH WHITE



C CARAMEL

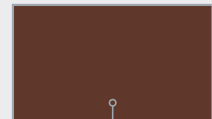

BR BROWN

GLASS & BRIDGE PACKERS

Flat and bridge packers guarantee glass alignment, squareness and maintain correct weight distribution

Moulded using prime grade material resistant to deterioration and unaffected by sealants

Other sizes are available on request

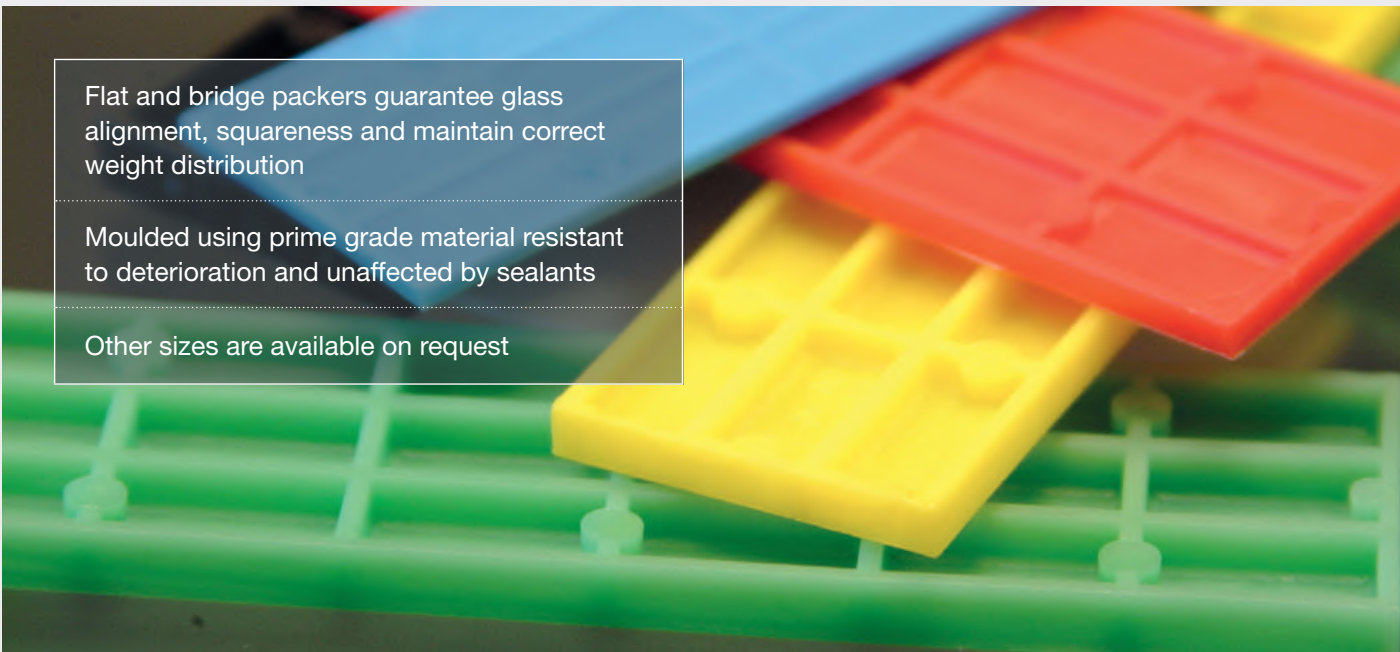

Bridge packers

Code	Size	Qty
BRP 325	5mm	1000 pk

30mm glass packers

Code	Size	Qty
FLWH 30	1000 pk	1mm
FLRE 30	1000 pk	3mm
FLE 30	1000 pk	4mm
FLGN 30	1000 pk	5mm

28mm glass packers

Code	Size	Qty
FLWH 28	1mm	1000 pk
FLBU 28	2mm	1000 pk
FLRE 28	3mm	1000 pk
FLYE 28	4mm	1000 pk
FLGN 28	5mm	1000 pk
FLBL 28	6mm	1000 pk
PP28 GP100	Mixed bag	100 pk

32mm glass packers

Code	Size	Qty
FLWH 32	1mm	1000 pk
FLBU 32	2mm	1000 pk
FLRE 32	3mm	1000 pk
FLYE 32	4mm	1000 pk
FLGN 32	5mm	1000 pk
FLBL 32	6mm	1000 pk
PP32 GP100	Mixed bag	100 pk
PP24 GP100	Mixed bag	100 pk

WINDOW CILLS & ACCESSORIES





COLOUR AVAILABILITY See table for colour codes and availability	Window cills and accessories colour finishes														
	AS 85 A-TYPE CILL	AC 125 A-TYPE CILL	AC 150 A-TYPE CILL	AC 180 A-TYPE CILL	AC 225 A-TYPE CILL	ECA 85 A-TYPE CILL	ECA125 A-TYPE CILL	ECA 150 A-TYPE CILL	ECA 180 A-TYPE CILL	ECA225 A-TYPE CILL	JT 150 JOINT TRIM	JTA 135 JOINT TRIM	JTA 150 JOINT TRIM	JTA 90E JOINT TRIM	JTA 90I JOINT TRIM
WGY4 Agate Grey	X	X	X	X	X	X	X	X	X	X	X	X	X	X	X
LO10 Anteak	X	X	X	X	X	X	X	X	X	X	X	X	X	X	X
WGY15S Anthracite Grey Smooth	●	●	X	X	●	X	X	X	X	X	X	X	X	X	X
7016 Anthracite Grey	●	●	●	X	X	X	●	●	●	●	X	X	X	X	X
BK Black	X	X	X	X	X	X	X	●	●	X	X	X	X	X	X
WY Black Ash	●	X	●	●	X	X	X	X	X	X	X	X	X	X	X
B Brown	X	X	X	X	X	X	●	●	●	●	●	●	●	●	●
BB Brown Beige (to match irish oak)	X	X	X	X	X	X	X	●	●	X	X	X	X	X	X
CO Caramel	X	X	X	X	X	●	●	●	●	●	●	●	●	●	●
WT1 Chartwell Green	X	X	X	X	X	X	X	X	X	X	X	X	X	X	X
CR Cream	●	●	●	●	●	●	●	●	●	●	X	X	X	X	X
WCR1 Cream White	●	●	●	X	X	X	●	●	●	●	X	X	X	X	X
WG Dark Brown (to match rosewood)	X	X	X	X	X	●	X	●	●	X	●	X	●	●	●
WO Golden Oak	●	X	●	●	X	X	X	X	X	X	X	X	X	X	X
WLO1 Irish Oak	●	X	●	●	X	X	X	X	X	X	X	X	X	X	x
GY3 Moondust Grey	X	X	X	X	X	X	X	X	X	X	X	X	X	X	X
O Oak	X	X	X	X	X	●	X	●	●	X	●	X	●	●	●
CO Oak on Caramel	●	X	●	●	X	X	X	X	X	X	X	X	X	X	X
RO Rosewood	●	X	●	●	●	X	X	X	X	●	X	X	X	X	X
7015 Slate Grey	X	●	X	X	●	X	●	X	X	●	●	X	X	X	X
64 White	●	●	●	●	●	●	●	●	●	●	●	●	●	●	●
WZ White Ash	●	X	●	X	●	X	X	X	X	X	X	X	X	X	X

KEY

- Available
- x Not available
- * Made to order

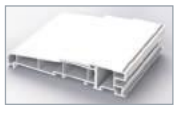
COLOUR OPTIONS: See table for colour availability

150mm A-type cill and end caps		Combinations		
Cill			CILL WITH EXTENDER See EWS 118 (below)	
Code	Qty		CILL WITH 25mm EXTENDER TRIM See EWS 106 (below)	
AC150	2 pack		CILL WITH 10mm EXTENDER TRIM See EWS 136 (below)	
End caps				
Code	Qty			
ECA 150	50 pairs			

85mm A-type cill and end caps			
Cill		End caps	
Code	Qty	Code	Qty
AS 85	4 pack	ECA 85	50 pairs

180mm A-type cill and end caps			
Cill		End caps	
Code	Qty	Code	Qty
AC180	2 pack	ECA 180	50 pairs

EWS 106	25mm x 6m knock on
	10 pack

EWS 136	10mm x 6m knock on
	10 pack

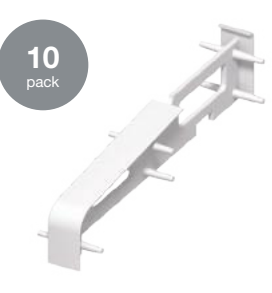
JT 150	150mm straight cill joint trim
	10 pack

JTA 150	150° angle cill joint trim
	10 pack
135° also available Code: JTA 135	

JTA 90i	90° internal angle joint trim
	10 pack

JTA 90E	90° external angle joint trim
	10 pack

UNS5821P	Cill reinforcement
	6m lengths

EWS 118	Cill extender
	6m lengths

CILL REPAIR COVERS

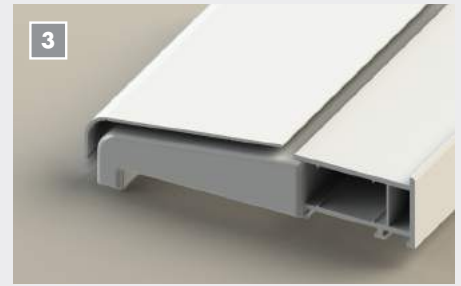
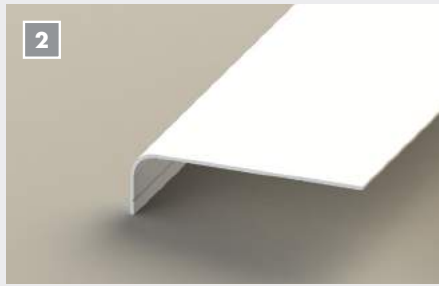

DAMAGED CILL REPLACEMENT

Quick repair of a damaged existing cill without the costly removal and replacement of the existing cill.

Extruded to fit AC225 perfectly it is trimmable to fit AC125, AC150 & AC180 by simply cutting down the extruded "V" on the underside of the cill.

Cill cover repair

Code	Size	Qty	Colour	
			Base	Foil
EWS119W	5m x 3.7m	5 pack	white	N/A
EWS119WO	5m x 3.7m	5 pack	white	Golden Oak
EWS119WRO	5m x 3.7m	5 pack	white	Rosewood
EWS119WGY1	5m x 3.7m	5 pack	white	Anthracite Grey

PERFECT PARTNER

With
SILVERSIL SUPER GLUE
ACTIVATOR and **SILVERSIL**
ADHESIVE.



BOW WINDOW ACCESSORIES

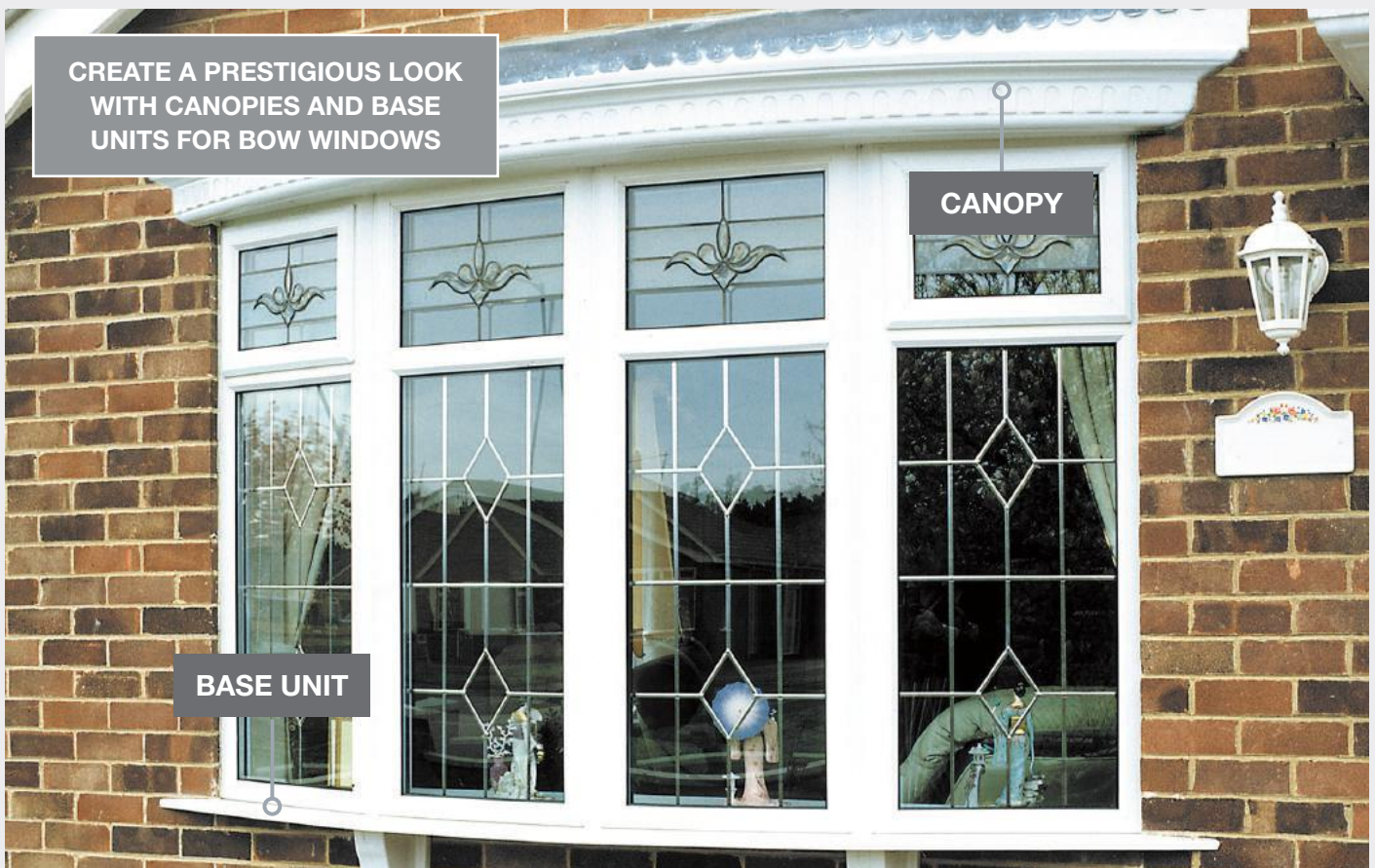

Bow canopies

- Quick and easy installation
- One piece leak-proof moulding
- Available with lead-look top
- Made from strong rigid fibreglass
- Maintenance-free

Standard

Code	Size	Qty
BC 18	1.8m	1 pack
BC 24	2.4m	1 pack

Foam filled

Code	Size	Qty
BC 18 FF	1.8m	1 pack
BC 24 FF	2.4m	1 pack

Bow units

- Quick and easy installation
- Fully moulded GRP base unit including attached gallows bracket
- Made from strong rigid fibreglass giving a firm foundation for a bow window

Standard

Code	Size	Qty
BA18 MK1	1.8m	1 pack
BA18 MK1	2.4m	1 pack

Gallows brackets



Code	Size
GB 7.5	7.5"
GB 10	10"
GB 713	2.4m

COLOUR OPTIONS



WH WHITE

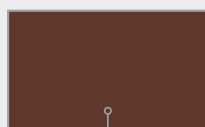

BR BROWN

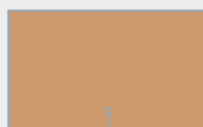

O OAK

WINDOW BOARDS

23MM LAMINATED WINDOW BOARDS

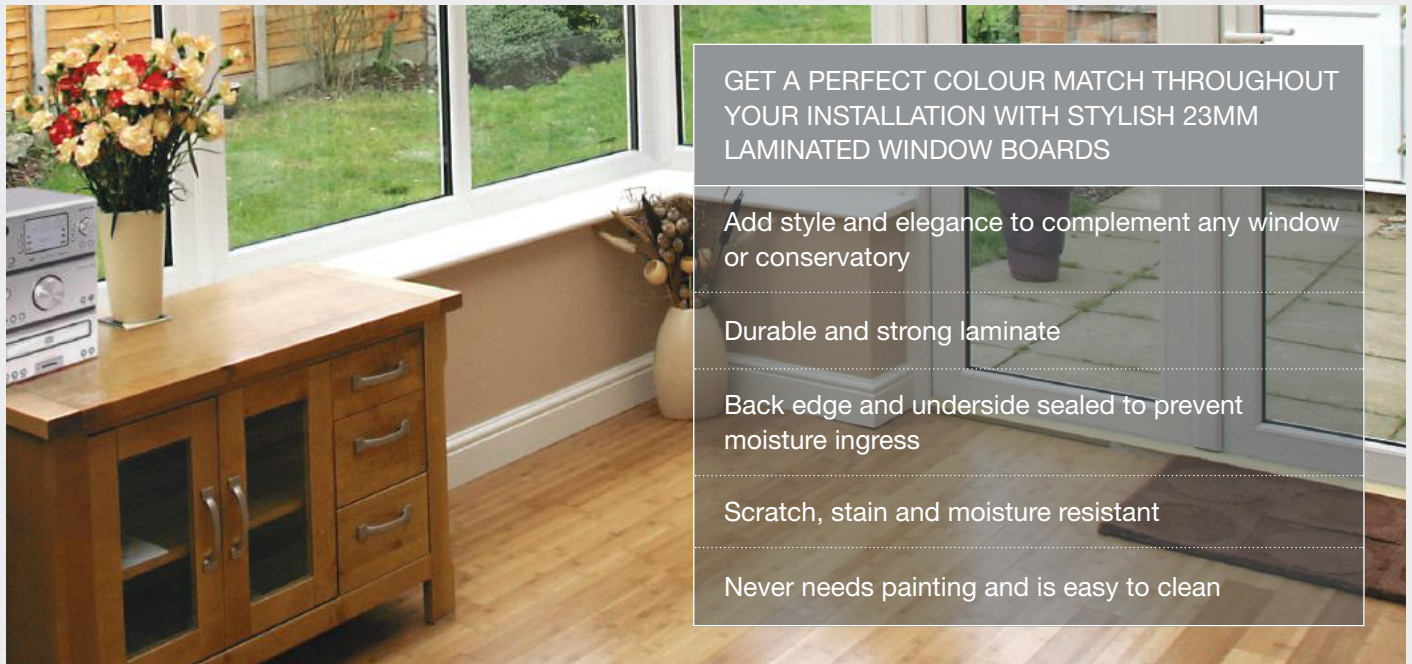

GET A PERFECT COLOUR MATCH THROUGHOUT YOUR INSTALLATION WITH STYLISH 23MM LAMINATED WINDOW BOARDS

Add style and elegance to complement any window or conservatory

Durable and strong laminate

Back edge and underside sealed to prevent moisture ingress

Scratch, stain and moisture resistant

Never needs painting and is easy to clean

23mm laminated window boards - Designer Range

Code	Width	Length	
		3m	4.1m
WT 100	100mm	X	●
WT 150	150mm	X	●
WT 180	180mm	X	●
WT 200	200mm	X	●
WT 225	225mm	X	●
WT 250	250mm	X	●
WT 300	300mm	X	●
WT 600	600mm	●	●
WT 900	900mm	●	●



KEY

● Available

x Not available

* Made to order



GREY ITALIAN SLATE (GIS)



BOSTON CONCRETE (BC)

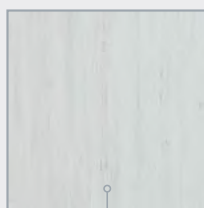

WHITE PAINTED OAK (WPO)

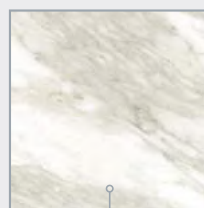

VENATO MARBLE (VM)

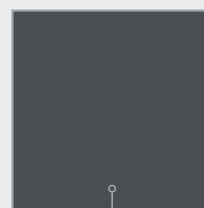

ANTHRACITE (AG)

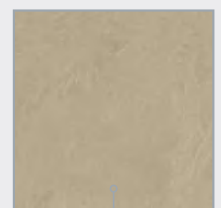

CREAM ITALIAN SLATE (CIS)

23mm laminated window boards - standard range

Code	Size	Qty
WT 100	100mm x 5m	1 pack
WT 150	150mm x 5m	1 pack
WT 180	180mm x 5m	1 pack
WT 200	200mm x 5m	1 pack
WT 225	225mm x 5m	1 pack
WT 250	250mm x 5m	1 pack
WT 300	300mm x 5m	1 pack
WT 600	600mm x 3m	1 pack
WT 600	600mm x 4.1m	1 pack
WT 900	900mm x 3m	1 pack
WT 900	900mm x 4.1m	1 pack

Colour options:

WH White / RW Rosewood / GO Golden Oak / LO Light Oak
 /CR Cream* / WZ White Ash* / GY Anthracite Grey (MTO)
 (*Except WT 300, WT 150 WT 180)



STANDARD RANGE COLOURS AVAILABLE

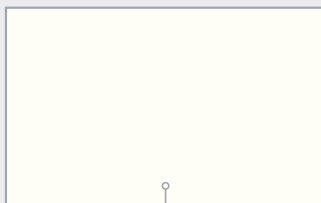

WHITE (WH)



CREAM (CR)

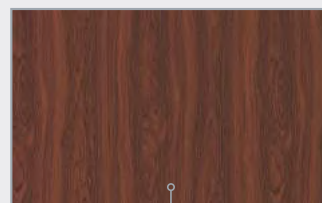

ROSEWOOD (RW)

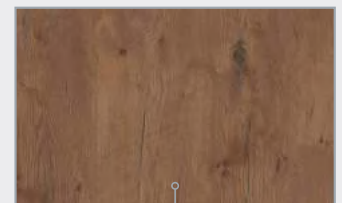

GOLDEN OAK (GO)

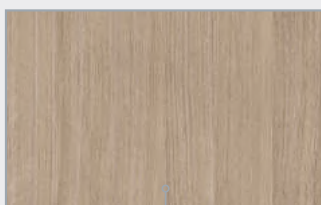

LIGHT OAK (LO)

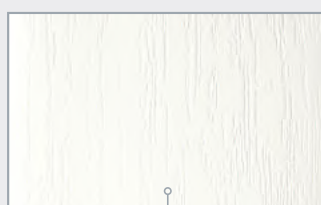

WHITE ASH (WZ)

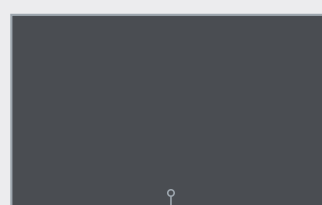

ANTHRACITE GREY (GY)

23MM LAMINATED TRIM

WTEC Laminated end cap



Foil options:
 WH White / ROF Rosewood /
 OF Golden Oak / WG Brown /
 LO2F Light Oak / CR Cream /
 AG Anthracite Grey / LG Light Grey / MG
 Medium Grey

WTJT Laminated joint trim



Foil options:
 WH White / ROF Rosewood /
 OF Golden Oak / WG Brown /
 LO2F Light Oak / CR Cream /
 AG Anthracite Grey / TK Teak / LG Light
 Grey / MG Medium Grey

WTUT Laminated universal trim



Foil options:
 64 White / RW Rosewood / WO Golden
 Oak / WG Brown / LO2 Light Oak / CR
 Cream / C Caramel / B Brown / AG
 Anthracite Grey / LG Light Grey / MG
 Medium Grey

9MM WINDOW BOARDS



9mm window boards		
Code	Size	Qty
WB 160	160mm x 5m	2 pack
WB 180	180mm x 5m	2 pack
WB 210	210mm x 5m	2 pack
WB 240	240mm x 5m	2 pack
WB 260	260mm x 5m	2 pack
WB 420	420mm x 5m	1 pack
Colour options: 64 White		

9MM WINDOW BOARD ACCESSORIES

EWS 129 Window board retaining trim
2 pairs

6m lengths



Colour options:
 W White / RWO Rosewood /
 WO Golden Oak

EWS 229 Window board retainer end cap
2 pairs

2 pairs

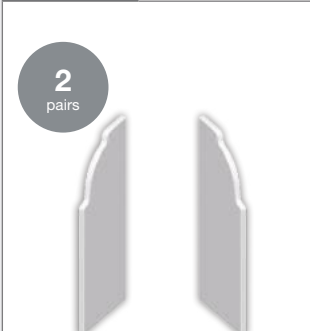

Colour options:
 W White / BRO Rosewood /
 CR Cream / CO Oak

DEC Long end caps
10 pairs

10 pairs



Colour options:
 64 White / O Golden Oak
 / WG Brown

EWBECS Short end caps
5 pairs

5 pairs

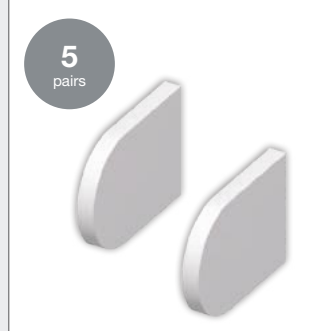

Colour options:
 64 White

finishing trims

EXPANDED TRIMS COLOURS RANGE

To enhance the current range of colours, our window trims* will be available in four new foiled finishes. These are: **Chartwell Green**, **Slate Grey**, **Moondust Grey** and **Anteak**

*Colour availability varies by product



EXAMPLES OF USE

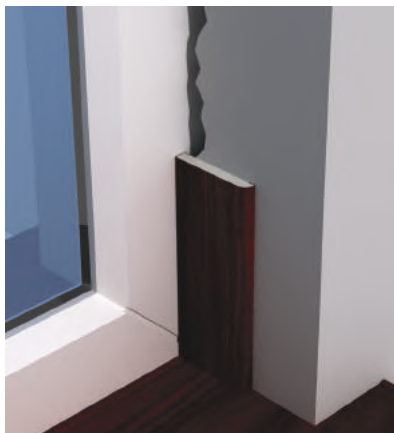

PENCIL ROUND ARCHITRAVE

This flatback pencil-round architrave hides minimal plaster damage, whilst providing an attractive finish. Available in 3 sizes.

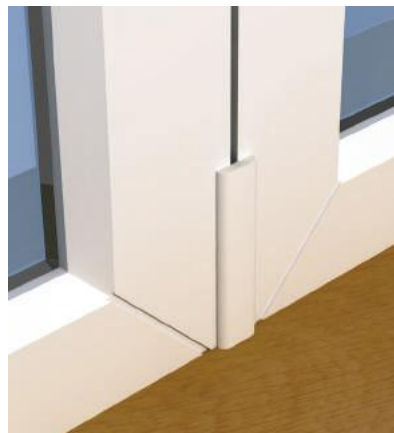

25MM D MOULDING

Conceal window joins with a 25mm D-moulding trim to improve sightlines and create a clean, colour-matched finish.



FOAM QUADRANT

Neaten joins with attractive foam quadrants, available in a variety of colours. Suitable for use around windows, floors and more.

FINISHING TRIMS



COLOUR AVAILABILITY See table for colour codes and availability	Finishing trims													
	QUADRANT Q13	QUADRANT Q17.5	D MOULD D25	BEAD B20	SQUARE S20	CLOAKING FILLET C20	CLOAKING FILLET C30	PENCIL ROUND PF45	PENCIL ROUND PF65	PENCIL ROUND PF90	ARCHITRAVE PR40	ARCHITRAVE PR60	ARCHITRAVE PR95	ARCHITRAVE OGEE50
64 White	•	•	•	•	•	•	•	•	•	•	•	•	•	•
CR Cream	•	•	•	X	X	•	X	•	•	•	X	X	X	X
WO Golden Oak	•	•	•	•	•	•	X	•	•	•	X	X	X	X
RO Rosewood	•	•	•	•	•	•	•	•	•	•	X	X	X	X
WLO1 Irish Oak	•	•	•	X	X	•	•	•	•	•	X	X	X	X
WZ White Ash	•	•	•	•	X	•*	•*	•	•	•	X	X	X	X
7016 Anthracite Grey	•*	•*	•	•	•	•	•*	•	•	•	X	X	X	X
GY1S Anthracite Grey Smooth	•	•	•	X	•	•	•	•	•	•	X	X	X	X
WY Black Ash	•	•	•	•	•	•	•	•	•	•	X	X	X	X
BW Blue White	•	•	•	•	X	•	•	•	•	•	X	X	X	X
WT1 Chartwell Green	•	•	•	•*	X	•*	•	•	•	•	X	X	X	X
CR1 Cream White	•	•	•	•*	X	•	•	•	•	•	X	X	X	X
GY3 Moondust Grey	X	X	X	X	X	•*	•*	•*	•*	•*	X	X	X	X
7015 Slate Grey	•	•	•	X	X	•	•	•	•	•	X	X	X	X
WGY2S Slate Grey Smooth	•	•	•	X	X	•	•	•	•	•	X	X	X	X
GY4 Agate Grey	•	•	•	•*	X	•*	•*	•*	•*	•*	X	X	X	X
LO10 Anteak	•*	•*	•	X	X	•*	•*	•*	•*	•*	X	X	X	X
GY17 Balmoral	•*	•*	•*	X	X	•*	•*	•*	•*	•*	X	X	X	X
WG Woodgrain	X	X	X	•	•	X	X	X	X	X	X	X	X	X
WG Woodgrain Brown	X	X	X	•	X	X	X	X	X	X	X	X	X	X

KEY • Available x Not available * Made to order



20
x 5m

Cloaking fillet

Code	Size
C 20	20mm
C 30	30mm



20
x 5m

13 or 17.5mm quadrant

Code	Size
Q 13	13mm
Q 17.5	17.5mm

PERFECT PARTNER

Seal trims with
SODAL SILIRUB LMN.



Look in-branch for full range

ARCHITRAVES



5m
lengths

Pencil round architrave Flat

Code	Size	Qty
PF 45	45mm x 5m	10 pack
PF 65	65mm x 5m	10 pack
PF 95	95mm x 5m	10 pack



5m
lengths

Pencil round architrave Castellated

Code	Size	Qty
PR 40	40mm x 5m	10 pack
PR 60	60mm x 5m	10 pack
PR 90	90mm x 5m	10 pack



5m
lengths

Ogee architrave Castellated

Code	Size	Qty
OGEE 50	40mm x 5m	10 pack

FINISHING TRIMS

ANGLES

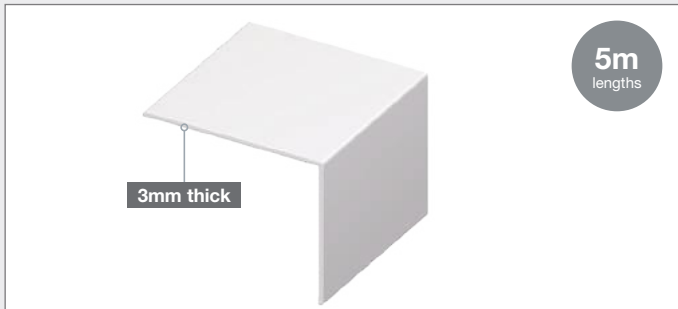

Rigid angles

Code	Size	Qty
RA 2525	25mm x 25mm	20 pack
RA 6060	60mm x 60mm	5 pack
RA 8080	80mm x 80mm	5 pack
RA 1008	100mm x 80mm	5 pack

Colour options:

64 White / RO Rosewood / WO Golden Oak / WGY1 Anthracite Grey (*Except RA6060, RA8080 & RA1008) / WY Black Ash (*Except RA6060, RA8080 & RA1008)

GRA 4040	40mm x 40mm	20 pack
RA 6535	150mm x 35mm	10 pack

Colour options:

64 White / RO Rosewood / WO Golden Oak / WGY1 Anthracite Grey (*Except RA 6535) / WY Black Ash (*Except RA 6535)



3mm thick adjustable angles

Code	Size	Qty
AA 50	50mm x 5m	20 pack
AA 70	70mm x 5m	20 pack
GAA 100	100mm x 5m	15 pack

Colour options:

64 White / WRO Rosewood / WO Golden Oak / WGY1 Anthracite Grey / (*Except AA70 & GAA 100) WY Black Ash (*Except AA70 & GAA 100)



6mm thick hollow angles

Code	Size	Qty
HA 1008	100mm x 80mm	5 pack

Colour options:

64 White / RO Rosewood / WGY1 Anthracite Grey / WY Black Ash

DRAIN SLOT COVERS



Drain slot covers

Code	Colour
900300	White
900301	Brown
900303	Tan
900304	Anthracite grey
900305	Black
900306	Cream
078165SAND	Sand
8165/CG	Chartwell green

COSMETIC REPAIRS



COLOUR EDGING PENS

Replace missing colour on window seams, wooden flooring and more

- Unique press action
- Spare tips included
- Suitable for interior and exterior applications
- Original colour edging pen with pump action is also available

Code **CEP**



WINDOW REPAIR KIT

Successfully repair minor scratches to windows

- Suitable for repairing minor scratches, dents or bruises to PVC-U and timber windows
- Contains filler for use on Mahogany, Rosewood, Golden Oak and White profile
- Original colour edging pen with pump action also available

Code **KO 614**



COLOUR FILL & SOLVENT PACK

Effectively repairs laminate and melamine flooring

Code **KO 614**

Colour options:
64 White / RW Rosewood / WO Golden Oak / O Oak

YOU CAN NOW GET AN INSTANT PRICE FOR YOUR BESPOKE WINDOW IN BRANCH TODAY!

With the launch of our new Frameworks technology, we can provide you with an instant price at your local branch.

Ordering couldn't be easier - just let our branch staff know the window style, size, colour and quantity.

Get your quote today!



FRAMEWORKS

ROOFLIGHTS

A bright dining room with a large skylight, a chandelier, and a bay window with wicker chairs. The skylight shows a view of a green tree against a blue sky. The room is filled with natural light from the windows and skylight. A chandelier hangs from the ceiling, and wicker chairs are visible in the foreground.

ROOFLIGHTS

CONTENTS

Rooflights	40
Fakro pivoting windows	40
Flat roof windows	42

- **Rooflights** are an ideal way to increase natural light on flat roof properties.
- **Fakro** pivoting roof window Comes with inbuilt TopSafe Anti Burglary system, and Head ventilator as standard. P2 Glazing unit with toughened outer pane and laminated inner pane.
- The **Fakro** type G product range includes flat roof windows which are non-opening (DXG), manually opening (DMG) or electrically operated (DEG)

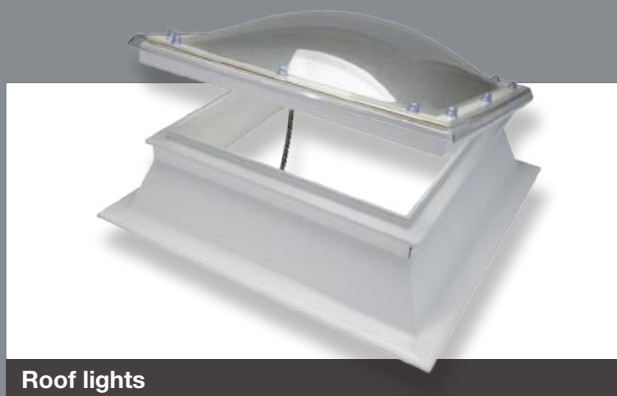

Roof lights



Fakro pivoting roof windows



Flat roof windows





ROOFLIGHTS

- Rooflights are an ideal way to increase natural light on flat roof properties.
- This product range offers high security and exceptional energy efficiency - with u-values as low as 1.8!
- The domed design offers great aesthetics, meaning they are desirable additions for residential and commercial applications.

**OTHER
DESIGNS
AVAILABLE**



GLAZING OPTIONS

- | | | |
|--|-----------------|--|
|  | CLEAR | <ul style="list-style-type: none"> • High light transmission • Allows unimpeded views |
|  | OPAL | <ul style="list-style-type: none"> • High light transmission • Allows unimpeded views |
|  | DIFFUSED | <ul style="list-style-type: none"> • Maximises privacy • Diffuses light to avoid sun glare |
|  | BRONZE | <ul style="list-style-type: none"> • Reduces solar heat gain • Reduced light-transmission |

Choice of ventilation options - ask a member of staff at your **local Eurocell branch today!**

Fakro pivoting roof window

- Comes with inbuilt TopSafe Anti Burglary system, and Head ventilator as standard. P2 Glazing unit with toughened outer pane and laminated inner pane.
- Practical and stylish design
- Suitable for 15-90 degree pitched roof
- U Value of 1.3 W/m²K
- Noise Reduction 32dB

FAKRO®



Code	Description
PTP-V01	55cm x 78cm Pivot Roof Window
PTP-V02	55cm x 98cm Pivot Roof Window
PTP-V05	78cm x 98cm Pivot Roof Window
ELV01	Slate Flashing 55cm x 78cm
ELV02	Slate Flashing 55cm x 98cm
ELV05	Slate Flashing 78cm x 98cm
EZV01	Tile Flashing 55cm x 78cm
EZV02	Tile Flashing 55cm x 98cm
EZV05	Tile Flashing 78cm x 98cm

FAKRO GB and EUROCELL present...

THE MAGNIFICENT SEVENTEN

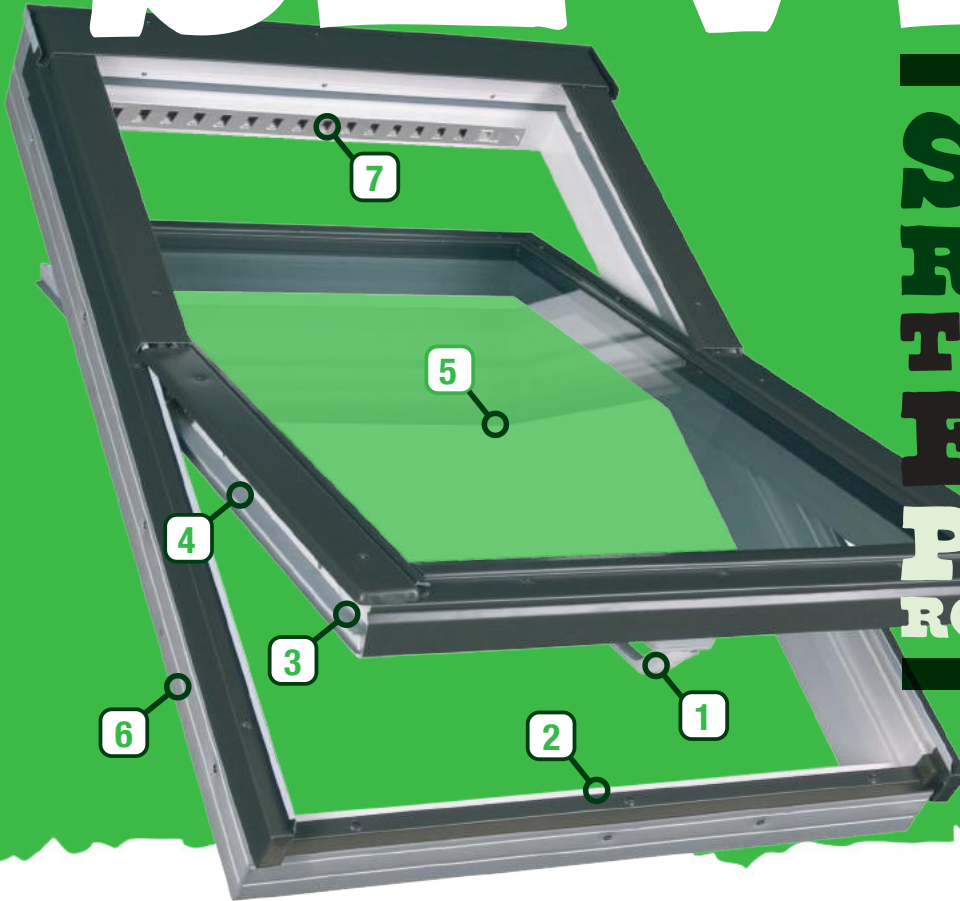

**SEVEN
REASONS
TO CHOOSE
FAKRO
PTP PVC
ROOF WINDOWS**

Starring :

Handle At The Bottom & TopSafe Anti Burglary

Featuring :

- Sash Guiding System • Quadruple Sealing System
- 1.3W/M2K Installed U-Value • Universal Bracket Fix System • V35 Air Inlet

Directed by : Eurocell

Produced by : FAKRO GB

AVAILABLE NOW
at your nearest Eurocell Branch



FAKRO®
FAKRO.CO.UK

FLAT ROOF WINDOWS

The ideal solution for providing natural daylight

The benefits of natural illumination of buildings are unquestionable but in those with flat roofs it is not always possible to install sufficient standard vertical windows. A source of natural light should be available in any living space to make its occupants feel comfortable. The ideal solution for providing light is the installation of specially designed products for flat roofs.



FLAT ROOF WINDOWS

Fakro flat roof window

- The Fakro type G product range includes flat roof windows which are non-opening (DXG), manually opening (DMG) or electrically operated (DEG). Fakro flat roof products bring the very highest standard of natural light to interiors. They also provide ventilation and offer exceptional functionality. In short, they can transform any room under a flat roof.
- The new range of technologically advanced G windows give smart aesthetics and provide an alternative solution for bringing natural daylight into rooms below a flat roof.
- Integral upstand for quick and easy installation.
- P2 safety glazing
- 10 year warranty



DEG

Electric z-wave control

- Electrically opened with wireless Z-Wave system,
- Included in the kit: AC adaptor, remote control, rain sensor
- Sash tilts 15cm

Code	Size
FRW80EX01	01K 60x60
FRW80EX02	02K 60x90
FRW80EX03	03K 70x70
FRW80EX04	04K 80x80
FRW80EX05	05K 90x90
FRW80EX06	06K 90x120
FRW80EX07	07K 100x100
FRW80EX08	08K 120x120
FRW80EX09	09K 140x140
FRW80EX10	10K 100x150
FRW80EX11	11K 120x200

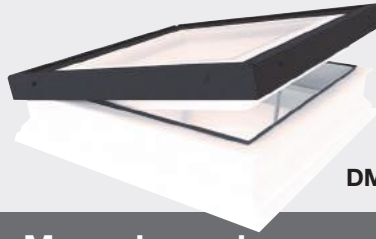

DMG

Manual opening

- Opened manually by means of ZSD control rod 2.2m long included
- Sash tilts 30cm

Code	Size
FRW80EW01	01K 60x60
FRW80EW02	02K 60x90
FRW80EW03	03K 70x70
FRW80EW04	04K 80x80
FRW80EW05	05K 90x90
FRW80EW06	06K 90x120
FRW80EW07	07K 100x100
FRW80EW08	08K 120x120
FRW80EW09	09K 140x140
FRW80EW10	10K 100x150
FRW80EW11	11K 120x200

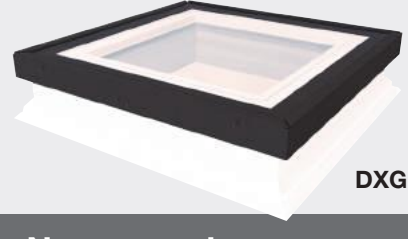

DXG

None opening

- Non-opening

Code	Size
FRW80EU01	01K 60x60
FRW80EU02	02K 60x90
FRW80EU03	03K 70x70
FRW80EU04	04K 80x80
FRW80EU05	05K 90x90
FRW80EU06	06K 90x120
FRW80EU07	07K 100x100
FRW80EU08	08K 120x120
FRW80EU09	09K 140x140
FRW80EU10	10K 100x150
FRW80EU11	11K 120x200

DOORS

DOORS

CONTENTS

Composite doors	46
PVC-U doors	54
PVC-U door canopies	58
Door surrounds	59
Sliding patio doors	61
PVC-U bi-fold doors	64
Aluminium bi-fold doors	66
French doors	68
Colour options	72
Garage doors	74



High security, low-maintenance and attractive composite, PVC-U and garage doors available in a range of colours and styles

- **Dales collection composite doors**
Our Dales Collection composite door range is better than ever! 16 stunning styles available.
- **PVC-U Bi-fold doors**
Why not open yourself up to a new business opportunity? Aspect is a new sensation in PVC-U folding sliding doors and are a hit with consumers – so why not start installing them today.
- **Aluminium bi-fold doors**
StudioGlide® isn't just a winning combination of high performance and thermal efficiency. Quality materials and advanced design make for a smooth, reliable sliding mechanism and frames that won't expand or contract, whatever extremes the weather throws at them.
- **Syncro sliding patio doors -**
A slim and attractive patio door - a perfect addition to your offering.



Dales collection composite door



PVC-U Bi-fold doors



StudioGlide Bi-fold doors



Syncro sliding patio doors

COMPOSITE DOORS

USE OUR ONLINE CONFIGURATOR TO START DESIGNING YOUR PERFECT COMPOSITE DOOR

eurocell®

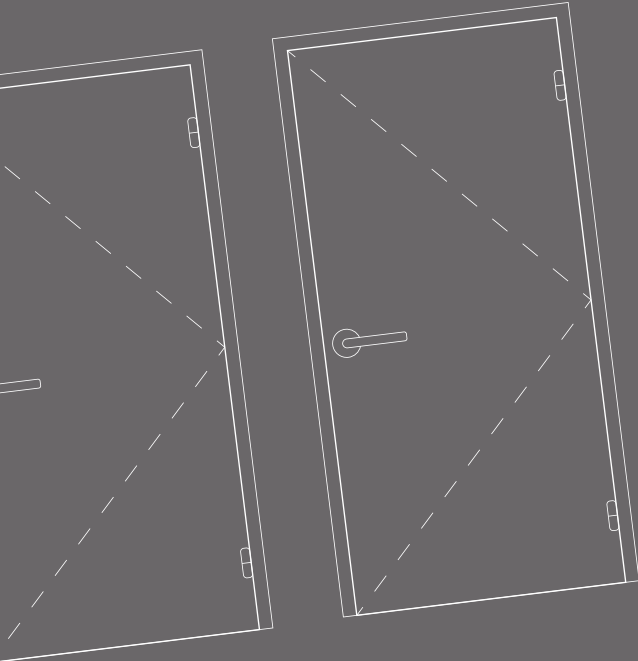

the dales collection



AVAILABLE
IN 16 DOOR
STYLES

CREATE THE PERFECT
STATEMENT DOOR

AVAILABLE IN
ANY RAL COLOUR*



COLOUR
OPTIONS ARE
ENDLESS

STYLE AND ULTRA
HIGH-SECURITY
ALL-IN-ONE
COMPOSITE DOOR



DESIGN NOW

To design your own door or for more information visit eurocell.co.uk

the dales collection

COMPOSITE DOORS



DOOR FURNITURE & GLASS STYLES NOW AVAILABLE

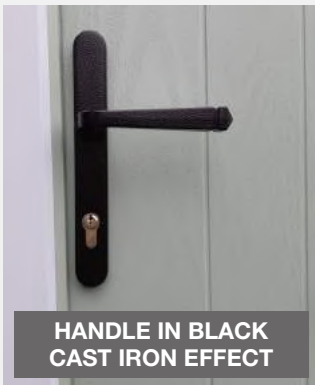

**HANDLE IN BLACK
CAST IRON EFFECT**



**LETTERBOX IN BLACK
CAST IRON EFFECT**



**GLACIER
GLASS**

For more information call us on 08000 77 88 88 today.

WHAT IS THE DALES COLLECTION?

the dales collection

This collection of composite doors from Eurocell offers better security, better sustainability and better aesthetics

FEATURES



INSULATED RIGID
FOAM INFILL PANEL

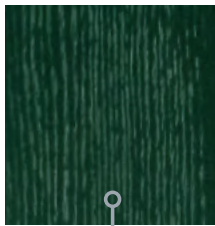

4MM TOUGH GRP
OUTER SKIN



ALUMINIUM
LOW THRESHOLD



TRIPLE-SEAL FRAME
WITH THERMAL
INSERTS

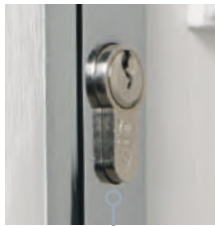

CYLINDER
LOCK



On door furniture.
Conditions apply

DOORS AVAILABLE ON A 6 DAY LEADTIME*

*This excludes doors from the Contemporary and Heritage and RAL colour ranges, doors with coloured interiors and doors with sidelights or toplights - all of which have an extended lead time.



VIDEOS



WATCH

See our **composite door promotional video** and **installation overview video** - offering tips for best practice when installing your door



Watch now at youtube.com/eurocellpvcu

DALES COMPOSITE DOORS



THE PERFECT REPLACEMENT DOOR IN 16 STUNNING STYLES

Triple-seal frame system ensures doors remain watertight even in the harshest weather conditions

3-way adjustable hinges mean they are quick and easy to install

Selection of stainless steel door furniture, covered by a 25-year guarantee

COLOUR OPTIONS

STANDARD RANGE

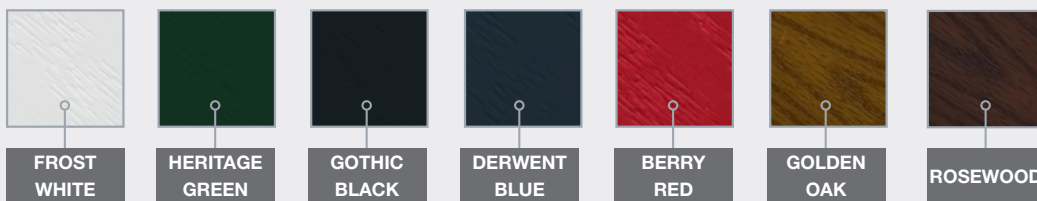

- PAS 23/24 for improved security
- Win-Mark
- B-rated doors as standard
- Association of Chief Police Officers' Secured by Design approved (subject to specification)



HERITAGE RANGE

Made-to-order - 11-day lead time applies



CONTEMPORARY RANGE

Made-to-order - 11-day lead time applies



THE DALES COLLECTION STYLES

THE DALES COLLECTION STYLES

INCLUDES TRIPLE-SEAL FRAME SYSTEM



The Bretton



The Chatsworth



The Chelmorton



The Hathersage



The Thorpe



The Winstar



The Newhaven



The Birchover



The Brassington



The Bradbourne



The Cromford



The Litton



The Middleton



The Wirksworth



The Elton



The Hartington

THE DALES COLLECTION GLASS STYLES

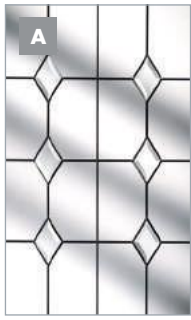

Other colours available

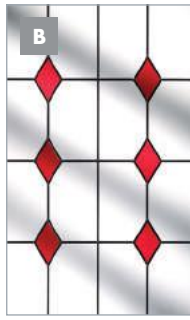

Other colours available

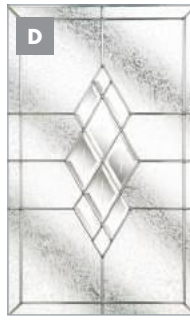
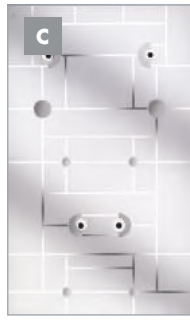

Other colours available

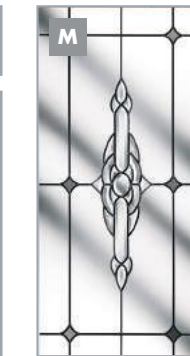
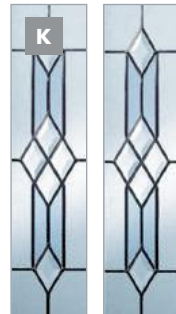
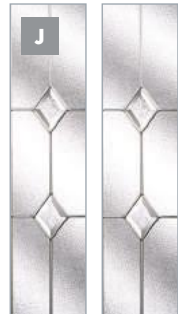
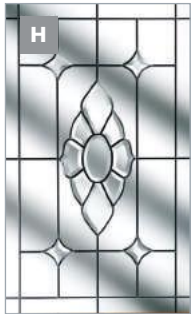

COLOUR VARIATIONS SEE TABLE FOR GLASS OPTIONS	Options			
	DOUBLE GLAZED	TRIPLE GLAZED	LEADING COLOUR	CHOICE OF BACKING GLASS
A. Bevel Diamond	●	X	X	●
B. Diamond	●	X	●	●
C. EOS	●	X	X	●
D. Kara	X	●	X	X
E. Lattice	●	X	X	●
F. Murano	●	X	X	●
G. Mene	●	X	X	●
H. Spirit	●	X	X	●
I. Standard	●	X	X	●
J. Diamond Classic	X	●	X	X
K. Prestige	●	X	X	●
L. Silvaner	●	X	X	●
M. Bohemia	●	X	X	●
N. Simplicity	X	●	X	X
O. Reflections	X	●	X	X
P. Dorchester	X	●	X	X
Q. Glacier	●	X	X	●

KEY

● Available X Not available

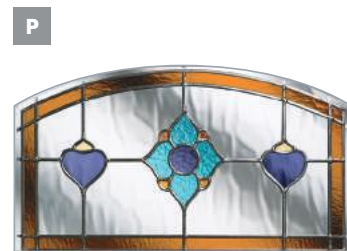

STAINLESS STEEL FURNITURE

Our door furniture range is ideal to complement The Dales Collection, whether you're looking for a chic, modern or traditional finish

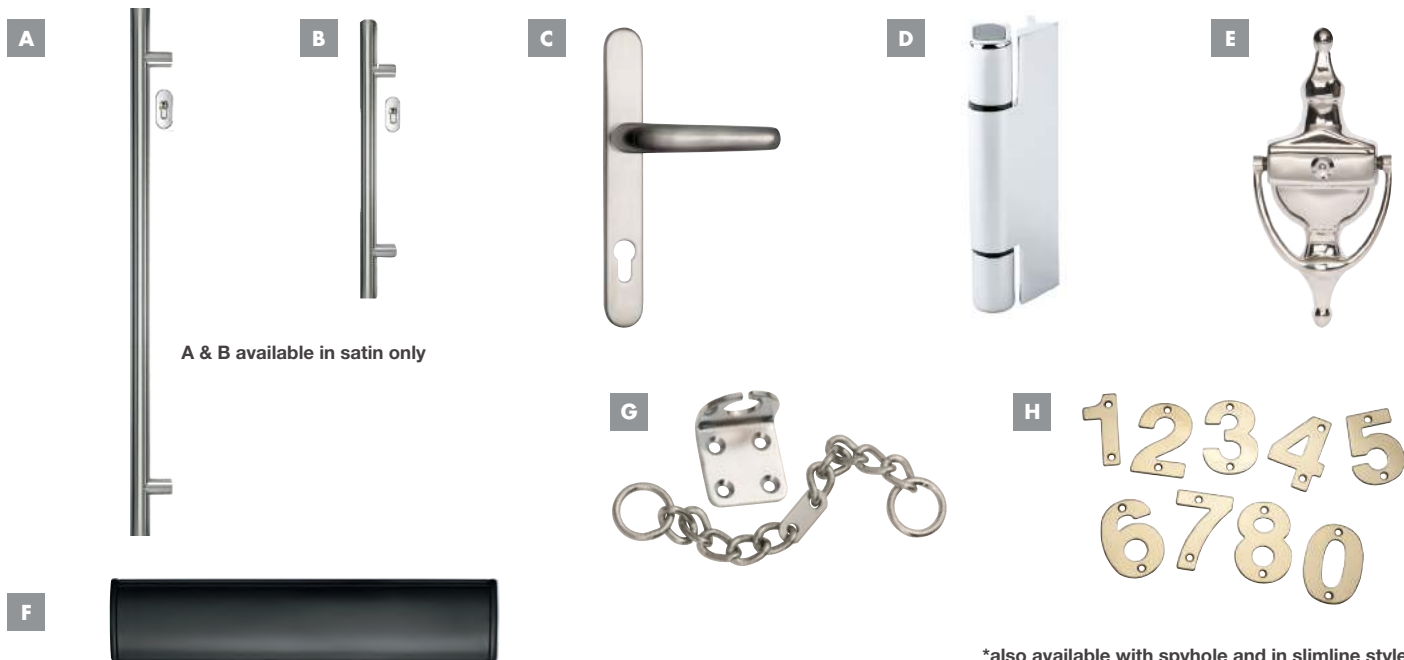

- A. Long bar
- B. Short bar
- C. Lever/lever
- D. Hinges
- E. Knocker
- F. Letterplates
- G. Door chain
- H. Numbers

COLOUR OPTIONS

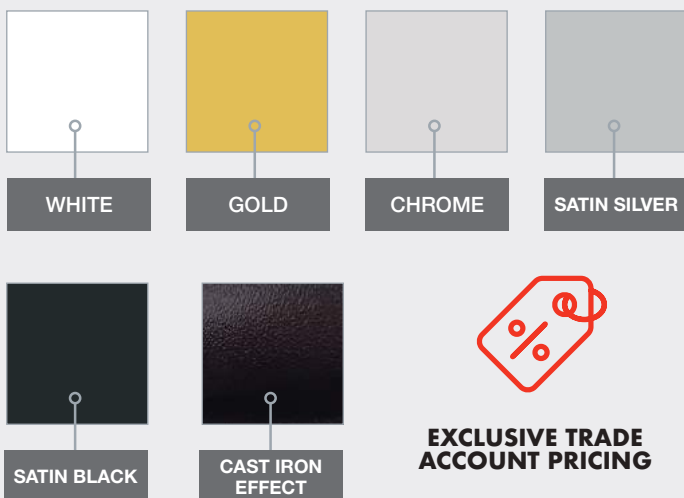

Available for handles and letterplate only

FURNITURE COLOURS



PVC-U DOORS

the elegance collection

VERSATILE DOORS
THAT WILL ENHANCE
ANY HOME

Extensive choice of
attractive, hard-wearing
doors in a choice
of styles

High levels of security

A range of glazing
options available

Thermally efficient

Heat and moisture
resistant

Inverted designs also
available





Victorian



Windsor

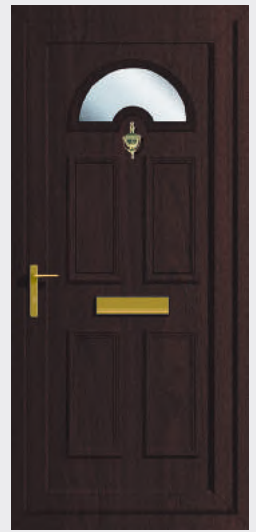

Georgian



Cornwall



Edwardian

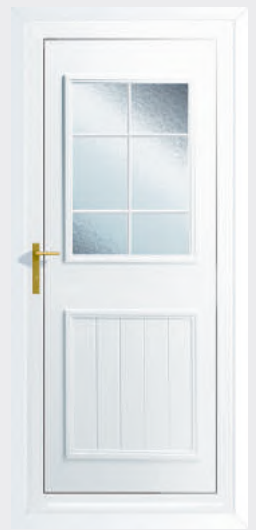

Regency

DOOR PANEL AND FRAME COLOURS (ALL WHITE INSIDE FOR BOTH)

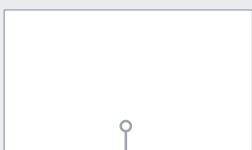

WHITE

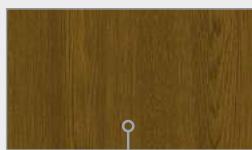

GOLDEN OAK



ROSEWOOD

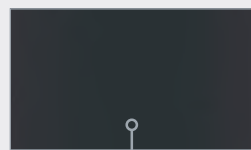

ANTHRACITE GREY
RAL 7016



CHARTWELL GREEN
RAL 6021

PVC-U DOORS - GLASS & HARDWARE

GLAZING STYLES AVAILABLE

may vary with door style



OBSCURE GLAZED

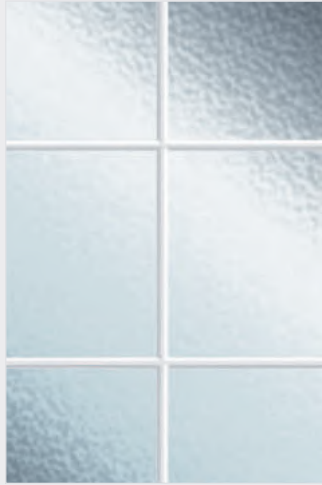

GEORGIAN BAR



CLIMBING ROSE

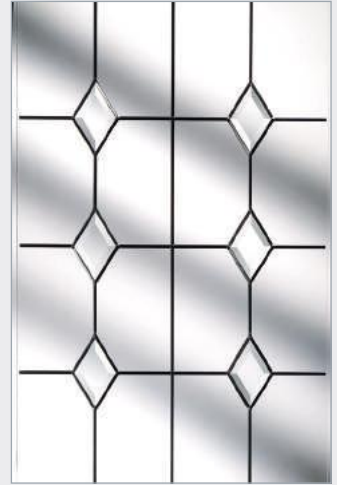

BEVEL CLUSTER

STAINLESS STEEL FURNITURE

LETTERPLATES



BLACK

GOLD

CHROME

SILVER

WHITE

URNS



BLACK



GOLD



CHROME



SILVER



WHITE



BLACK

NUMBERS AND LETTERS (A-D ONLY)



GOLD

SPYHOLES



BLACK



GOLD



CHROME



WHITE



CHROME



**SPEAR &
JACKSON**



TOOLBOX ESSENTIALS

Spear & Jackson Predator UPVC Saw

A fine cutting saw for
UPVC and hard plastics



Our range of Predator hardpoint saws have been specifically developed to meet the needs of even the most demanding professionals.

Our Predator saws are heat-treated using the latest technology to ensure outstanding durability and performance.

- Fast cut - smooth, clean cutting action
- Rigid blade minimises whip and vibration
- Ideal for cutting UPVC sills, trims, and pipes
- Suregrip soft feel ergonomic grip and finger guide for improved accuracy, with a 45/90° angle guide
- 20" harden and tempered carbon steel blade
- 14 PPI Hardpoint teeth

DON'T FORGET to pick your 5m and 8m heavy duty tape measures online or in store.



**For more information email:
sales@spear-and-jackson.com
or visit: www.spear-and-jackson.com**



PVC-U DOOR CANOPIES



**GET QUICK QUOTES
ON OUR MTO PRODUCTS**

**IDEAL FOR NEW BUILD
AND REFURBISHMENT
PROJECTS**

Suitable for a variety of
entrance doors

Designed GRP material is
low-maintenance - it will
never need repainting!

The ripley



Flat top, lead-look canopy with scalloped edge and Georgian period detailing will add prestige to any property

Code	Size
RIP 1500	1500mm

Colour options:
WH White

The cheltenham



3
designs

This strong, rigid GRP dual pitch canopy with tile effect roof and imitation woodgrain detailing is available with 3 design options on the gable

Code	Style
CHELT 730	730mm std
CHELT 730F	730mm fleur
CHELT 730T	730mm t-bar

Colour options:
WH White

The rockingham

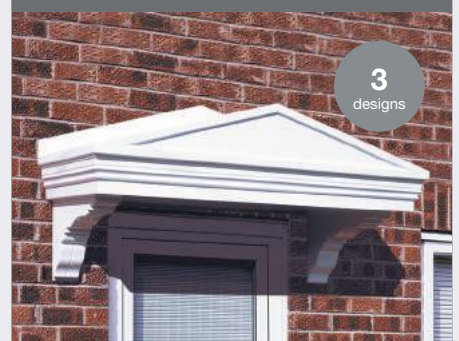

3
designs

Elegant Victorian style GRP door canopy incorporating fully moulded brackets offers a period look for your customers

Code	Style
ROC B	With brackets
ROB WB	No brackets
ROC CL	Lead-top effect

Colour options:
WH White

DOOR SURROUNDS

THE VICTORIAN



GET QUICK QUOTES
ON OUR MTO PRODUCTS

Add prestige to entrance doors

Code	Colours
VTPS	WH White

THE GEORGIAN



GET QUICK QUOTES
ON OUR MTO PRODUCTS

This regal design will enhance any doorway

Code	Colours
G TPS	WH White

FREESTANDING COLUMNS

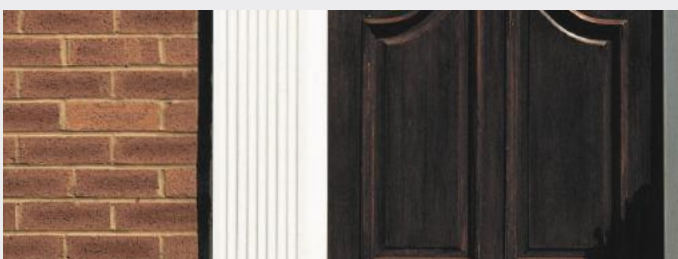

The finishing touch to entrance doors

Code	Style
FP	Flat pillar
COLPL	Plain column
RCOLFLU	Fluted column
Colour options: WH White	



BUILDING PLASTICS AND A WHOLE LOT MORE. YOUR ONE-STOP SHOP.

**GET A TRADE ACCOUNT TODAY
AND GET A WHOLE LOT MORE.**

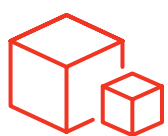

**OVER 6000
PRODUCTS AVAILABLE
IN-BRANCH**



**200+ BRANCHES
NATIONWIDE**



**£2,000 INSTANT
TRADE CREDIT**



**EXCLUSIVE TRADE
ACCOUNT PRICING**



**ONLINE TRADE
ACCOUNT**



**DEDICATED
ACCOUNT MANAGER**



SIGN UP TODAY. ASK IN BRANCH TODAY FOR MORE DETAILS.



**SHOP 24/7
EUROCELL.CO.UK**



**CLICK & COLLECT
IN-BRANCH**



**FREE ONSITE
DELIVERY***



BUILDING PLASTICS

*Longer lead times apply to made-to-order items. Applies to mainland UK only and excludes Northern Ireland & Northern Scotland. Minimum order value of £50.

SLIDING PATIO DOORS

SLIM AND ATTRACTIVE PATIO DOORS - A PERFECT ADDITION TO YOUR OFFERING



syncro®

THE PATIO DOOR THAT REALLY OPENS THINGS UP.

- 2, 3 or 4 pane options
- Sustainable with frame composition made up of at least 40% PCW (post- consumer waste)
- Maximum width of 3.5m (2 pane) and a maximum sash width of 1750mm
- Grey substrate option for total coordination with modern designs
- Triple as well as double glazing compatible for even better insulation
- Better thermal efficiency with U-values as low as 1.3 for double glazed units and 1.0 for triple glazed
- Soft close option

SLIDING PATIO DOORS

**FEATURING:
A SOFT CLOSE OPTION &
GREY SUBSTRATE**

For more information visit
eurocell.co.uk/syncro

syncro®

CONSISTS OF 40% RECYCLED
POST-CONSUMER PVC-U

U-VALUE
AS LOW AS 1.0

GREY SUBSTRATE FOR
THE CONSISTENT LOOK

WIDTHS OF UP TO
3.5 METRES (2 PANE)

FEATURING A
SOFT CLOSE OPTION

More sustainable, secure, thermally efficient and stronger than any previous design, the new Syncro patio door system perfectly aligns with the latest regulations. While its looks, options and market-leading maximum width of 3.5m help it perfectly coordinate with any design requirement.

Soft close eases door on closure to locking position

PVC-U BI-FOLD DOORS



FEATURING:

**SMOOTH OPENING & SUPERIOR GLIDE
BI-DIRECTIONAL ROLLER SYSTEM**



**SUPERIOR GLIDE
FROM 8 INBUILT ROLLERS**



**INTELLIGENT
BY DESIGN**

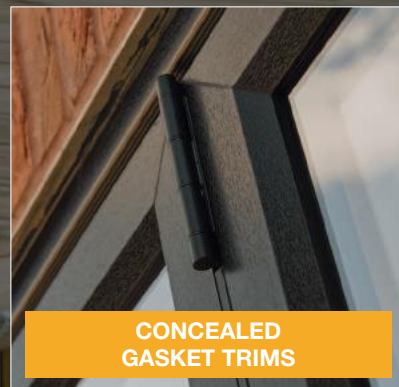

**CONCEALED
GASKET TRIMS**

**For more information visit
eurocell.co.uk/aspect**

aspect®

Beautifully designed, easy to install PVC-U bi-fold doors

NOW AVAILABLE WITH GREY SUBSTRATE FOR THE CONSISTENT LOOK



Main image courtesy of Lissett Homes

The first bi-fold door on the UK market to achieve BBA certification and Secured by Design accreditation



AVAILABLE WITH PART M THRESHOLD



Certificate number
13/5043



DOCUMENT Q COMPLIANT

For more information call us
on **08000 77 88 88** today.

ALUMINIUM BI-FOLD DOORS

DESIRABLE.

SCALABLE. DURABLE.

STUDIOGLIDE® BI-FOLD DOORS

U1.3

ENVIRONMENTAL PERFORMANCE

U-values as low as 1.6W/m²k for double glazing and 1.3 W/m²k for triple glazing



INCREASED SCALABILITY

Endless possibilities with a maximum frame height of 2.5m and width of 6.5m and individual sashes that can be up to 1.2m wide



MINIMAL SIGHT LINES

Minimal profiles for a modern look and inline system with sash and outer frame of the same depth

10
YEAR

PEACE OF MIND

10-year guarantee. Tested to BS6375 2015. PAS 24 accredited for security

STUDIO

Glide®



THE HIGH-
PERFORMANCE
ALUMINIUM
BI-FOLD.

StudioGlide® isn't just a winning combination of high performance and thermal efficiency. Quality materials and advanced design make for a smooth, reliable sliding mechanism and frames that won't expand or contract, whatever extremes the weather throws at them.



For further information
visit studioglide.co.uk

FRENCH DOORS



Stylish versatility

Flexible and sophisticated, Lifestyle French doors are available in a range of sizes up to 2 metres wide, providing an impressive entrance to your garden. A tasteful choice of colours allows your doors to complement your home or conservatory. Whether you are looking for classic White or elegant Cream, or if you prefer the natural appearance of Rosewood or Golden Oak, we have a style that's right for you.

Individual design

A choice of frame styles – Chamfered or Ovolo and a choice of opening options mean you can tailor the finish of your French doors to your individual taste. Inward opening allows you to make the most of your patio space or you can maximise your indoor areas with an outward opening mechanism.



Ovolo
(Sculptured)

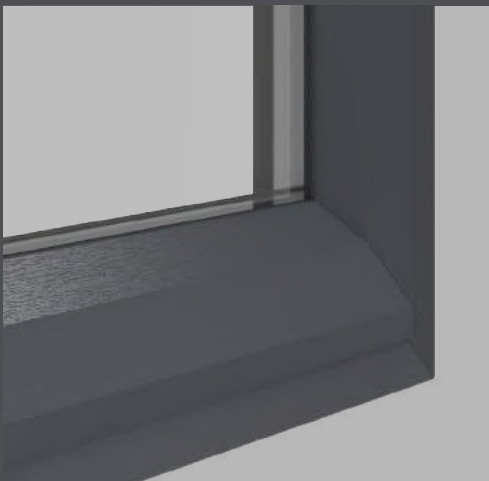

Chamfered
(Straight edge)



Flush Sash
(Square)

FLUSH FRENCH DOORS



The flush option

Offering all the benefits of French Doors, our flush option replicates a timber aesthetic giving a beautiful finish to any home without the need for regular maintenance. The design of our flush French Door means it perfectly suites into traditional or more contemporary properties and the extensive range of colour options available allows you greater variety to reflect your personal style.



COLOUR OPTIONS

aspect® BI-FOLD DOORS / logik™ FLUSH FRENCH DOORS



WHITE
White interior



WHITE ASH†
Both sides



IRISH OAK†
White interior



IRISH OAK†
Both sides



GOLDEN OAK
White interior



GOLDEN OAK
Both sides

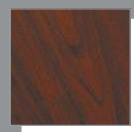

ROSEWOOD
White interior



ROSEWOOD
Both sides

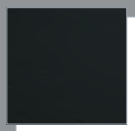

BLACK ASH*
White interior



ANTHRACITE
GREY*
White interior



ANTHRACITE
GREY*
Grey base

HARDWARE COLOURS



WHITE



BLACK



SATIN
SILVER



SILVER GREY

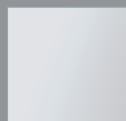

BRIGHT
CHROME



CHAMPAGNE

studio Glide® ALUMINIUM BI-FOLD DOORS



WHITE
Both sides



BLACK
Both sides



ANTHRACITE
GREY
Both sides



ANTHRACITE
GREY
White interior

HARDWARE COLOURS



WHITE



BLACK



ANTHRACITE
GREY



BRUSHED
SATIN



CHROME

† Ovolo only * Chamfered only * MTO

Note: Anthracite Grey with Grey base features cool colours foil

logik™ FRENCH DOORS



WHITE
White interior



WHITE ASH†
Both sides



IRISH OAK†
White interior



IRISH OAK†
Both sides



GOLDEN OAK†
White interior

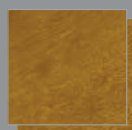

GOLDEN OAK
Both sides

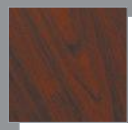

ROSEWOOD
White interior

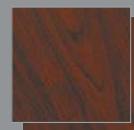

ROSEWOOD
Both sides



CREAM
WHITE†
White interior



CHARTWELL
GREEN†
White interior



OLIVE
GREEN†
White interior



DARK RED
White interior



BLUE†
White interior



SLATE GREY*
White interior



ANTHRACITE
GREY*
White interior

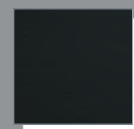

BLACK ASH*
White interior



ANTHRACITE
GREY*
Grey base

HARDWARE COLOURS



WHITE



BLACK



ANTHRACITE
GREY



BRUSHED
SATIN



CHROME

† Ovolo only * Chamfered only

Note: Anthracite Grey with Grey base features cool colours foil

syncro® PATIO DOORS



WHITE
White interior



GOLDEN
OAK
White interior

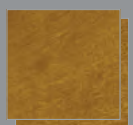

GOLDEN
OAK
Both sides



ROSEWOOD
White interior

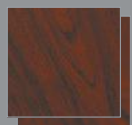

ROSEWOOD
Both sides



ANTHRACITE
GREY
White interior



ANTHRACITE
GREY
Grey base



ANTHRACITE
GREY SMOOTH *
Grey base

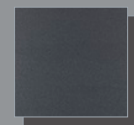

ANTHRACITE
GREY MATT *
Grey base

HARDWARE COLOURS



WHITE



HARDEX
CHROME

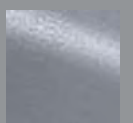

HARDEX
GRAPHITE

GARAGE DOORS



- STRONG, SECURE AND LIGHTWEIGHT GARAGE DOORS - SUITABLE FOR EVERY HOME!
- High quality, low-maintenance design
- Glazing available on certain styles
- Two-point locking as standard on Up & Over doors
- Full range of sizes including single (7'0, 7'6 and 8'0 wide) and doubles (up to 14'0)
- Superior lifting gear on Up & Over doors
- Choose from up to 18 colours
- Embossed with 20% deeper pattern

**SECTIONAL
& ROLLER
DOORS
AVAILABLE**



Up & over doors



Roller doors



Sectional doors



Side hinged doors

GARADOR GARAGE DOORS



Carlton

- Steel Up & Over Door.
- Low maintenance.
- Choice of 18 colours.



Horizon

- Steel Up & Over Door.
- Low maintenance.
- Choice of 18 colours.



Windsor

- Steel Up & Over Door.
- Low maintenance.
- Choice of 18 colours.

Add a quick fit steel frame



Design 210

- Steel Up & Over Door.
- Brushed steel handle.
- Plus, Anthracite Grey colour option.



Georgian

- Steel Up & Over Door.
- Perfect for modern & traditional homes.
- Choice of 18 colours.



Beaumont

- Steel Up & Over Door.
- Low maintenance.
- Canopy or track gear.
- Choice of 18 colours.

Choose from 18 colours

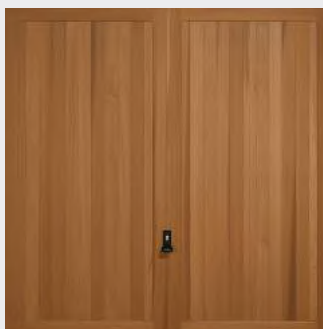

Kingsbury

- Timber Up & Over Door.
- Constructed from solid red cedar.
- Choice of 6 stain options

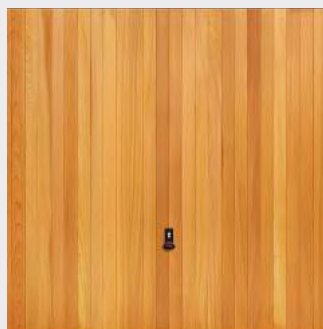

Vertical Cedar

- Timber Up & Over Door.
- Constructed from solid red cedar.
- Choice of 6 stain options

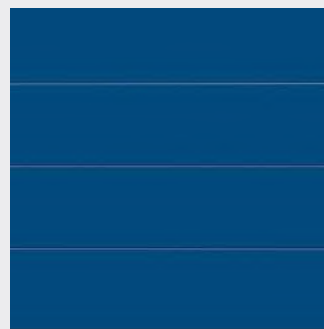

Linear Large

- Sectional Door.
- Full drive through width and height.
- 42mm thick insulated design.

Automate your garage door



HARDWARE

CONTENTS

Locks	79
Handles - door	83
Hinges	83
Letterplates	83
Centre strikers/cases	84
Handles - window	84
Restricters	86

- Eurocell offers a wide selection of Door Hardware, Window Hardware, Additional Security, Architectural Ironmongery and Tools for repair and maintenance.
- 3000+ hardware products including obsoleted ranges.



THE KEY TO HASSLE-FREE LOCK REPLACEMENT IS IN YOUR HANDS



Don't let your customers fall victim to insurance company small print

- **QUICK AND EASY REPLACEMENT**
- **INSURANCE RECOGNISED**
- **BS EN 1303 LEVEL**



ANTI DRILL



ANTI SNAP



ANTI PICK

EURO DOUBLE CYLINDER
KEY TO KEY



EURO TURN CYLINDER
KEY TO TURN



3 SEPARATE LINES OF DEFENCE

IN STOCK AT YOUR LOCAL BRANCH



DETERS THE MOST DETERMINED ATTACK!

It's a fact that more insurance companies are now specifying that high performance locks such as the Schlosser Anti-Snap Cylinder are fitted before paying out claims. Just look at the great built-in security features opposite:

1 SNAP-OFF FRONT SECTION

If attacked, the cylinder will break off, giving the intruder less of the cylinder to grip.

2 HARDENED GRIP DEFLECTORS

Make gripping the rest of the cylinder difficult.

3 HARDENED REINFORCED BAR

This is designed not to snap, but to flex in a way that will defeat the majority of intruders.

REPLACEMENT CYLINDER LOCKS

For budget-conscious customers, there is the Euro Profile Cylinder. Available with single cylinder, double cylinder and turn cylinder

- 1 6-pin Euro profile cylinder
- 2 Quick and easy replacement for existing cylinder
- 3 Tested to BS EN 1303:2005
- 4 Available in polished brass and nickel

EURO PROFILE CYLINDER



EURO CYLINDERS

STANDARD SECURITY



SNAP PROTECTION AS STANDARD!

- ✓ 3 KEYS
- ✓ DUAL FINISH
- ✓ NON-HANDED
- ✓ BS EN1303 STANDARD
- ✓ VERTICAL KEY
- ✓ SNAP-SAFE PROTECTION



3 STAR SECURITY



- ✓ 5 KEYS
- ✓ DUAL FINISH
- ✓ NON-HANDED
- ✓ BRITISH STANDARD 3 STAR
- ✓ SOLD SECURE DIAMOND GRADE
- ✓ SECURED BY DESIGN APPROVED
- ✓ PATENTED TRAP PIN SYSTEM



SCHLOSSER TECHNIK SNAP-SAFE, ANTI-PICK AND ANTI-DRILL EURO CYLINDER

Don't let your customers fall victim to insurance company small print – choose insurance-backed Schlosser replacement locks – in-branch now!

3 STAR SECURITY CYLINDER LOCKS



- 5 keys
- Dual finish
- Non-handed
- British Standard 3 star

- Sold Secure Diamond Grade
- Secured By Design Approved
- Patented Trap Pin System

Anti-drill, anti-pick and anti-tamper

- Snap safe
- 3* Kitemark

Schlosser Technik 3* Key to Key Euro Cylinder

Tested to BS EN 1303 and supplied with 3 keys

Code	Size
UC3-3535D	35/35 Dual finish
UC3-3540D	35/40 Dual finish
UC3-3545D	35/45 Dual finish
UC3-3555D	35/55 Dual finish
UC3-4040D	40/40 Dual finish
UC3-4045D	40/45 Dual finish
UC3-4050D	40/50 Dual finish
UC3-4055D	40/55 Dual finish
UC3-4060D	40/60 Dual finish
UC3-4545D	45/45 Dual finish
UC3-4550D	45/50 Dual finish
UC3-4555D	45/55 Dual finish
UC3-5050D	50/50 Dual finish
UC3-5055D	50/55 Dual finish

Schlosser Technik 3* Key to Turn Euro Cylinder

Dual Finish - EN 1303 - 3 Keys

Code	Size
UC3-35T35D	35T/35 Dual finish
UC3-35T45D	35T/45 Dual finish
UC3-35T55D	35T/55 Dual finish
UC3-40T40D	40T/40 Dual finish
UC3-40T45D	40T/45 Dual finish
UC3-40T50D	40T/50 Dual finish
UC3-40T55D	40T/55 Dual finish
UC3-40T60D	40T/60 Dual finish
UC3-45T45D	45T/45 Dual finish
UC3-45T50D	45T/50 Dual finish
UC3-45T55D	40T/55 Dual finish
UC3-50T40D	50T/40 Dual finish
UC3-50T45D	50T/45 Dual finish
UC3-50T50D	50T/50 Dual finish
UC3-50T55D	50T/55 Dual finish
UC3-55T45D	55T/45 Dual finish
UC3-55T50D	55T/55 Dual finish
UC3-60T40D	60T/40 Dual finish

STANDARD CYLINDER LOCK



Schlosser Technik Snap-Safe Key to Key Euro Cylinder

Tested to BS EN 1303 and supplied with 3 keys

Code	Size
UE63030D	30mm/30mm (60mm)
UE63535D	35mm/35mm (70mm)
UE63540D	35mm/40mm (75mm)
UE63545D	35mm/45mm (80mm)
UE64040D	40mm/40mm (80mm)
UE64045D	40mm/45mm (85mm)
UE63555D	35mm/55mm (90mm)
UE64050D	40mm/50mm (90mm)
UE64545D	45mm/45mm (90mm)
UE64555D	45mm/55mm (90mm)
UE64055D	40mm/55mm (95mm)
UE64550D	45mm/50mm (95mm)
UE64060D	40mm/60mm (100mm)
UE65050D	50mm/50mm (100mm)

Schlosser Technik Snap-Safe Key to Turn Euro Cylinder

Dual Finish - EN 1303 - 3 Keys

Code	Size
UE630T30D	30T/30 (60mm)
UE635T35D	35T/35 (70mm)
UE635T45D	35T/45 (80mm)
UE640T40D	40T/40 (80mm)
UE640T45D	40T/45 (85mm)
UE635T55D	35T/55 (90mm)
UE640T50D	40T/50 (90mm)
UE645T45D	45T/45 (90mm)
UE650T40D	50T/40 (90mm)
UE640T55D	40T/55 (95mm)
UE645T50D	45T/50 (95mm)
UE650T45D	50T/45 (95mm)
UE655T40D	55T/40 (95mm)
UE640T60D	40T/60 (100mm)
UE645T55D	45T/55 (100mm)
UE650T50D	50T/50 (100mm)
UE660T40D	60T/40 (100mm)

SCHLOSSER TECHNIK SNAP-SAFE, ANTI-PICK AND ANTI-DRILL EURO CYLINDER

Don't let your customers fall victim to insurance company small print – choose insurance-backed Schlosser replacement locks – in-branch now!

PVC-U Door repair lock kit

Kit contains:

1x four roller multi-point lock, 1x reversible one piece keep
8x multi-fit keep packers

- 28mm, 30mm, 35mm backset
- Lever / lever, night latch operation
- 92mm PZ centres
- Latch, deadbolt & 4 rollers

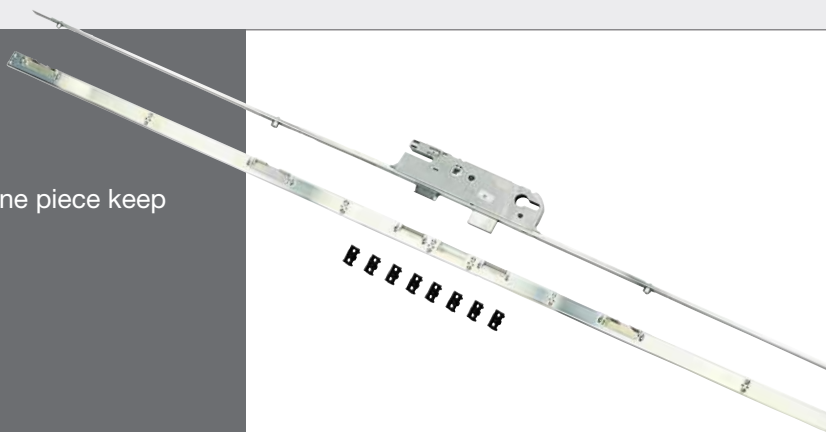

Code	Style
MPL3255K-35LL	35/92 4 Roller Repair Lock Kit
MPL3255K-30LL	30/92 4 Roller Repair Lock Kit
MPL3255K-28LL	28/92 4 Roller Repair Lock Kit

**PERFECT
PARTNER**
Seal trims with
SILICONE SPRAY.



Garage door lock

Code	Style
GDL13800	Garage Door Lock

HARDWARE

Sparta sprung door handle



Code

Size

ST-DH4636ST 122mm fixing crs/92mm PZ

ST-DH4645ST 210mm fixing crs/92mm PZ

Colour options: CH Chrome, GO Gold, WH White

Schlosser sprung door handle



Apto L/L 70 Sprung - 180 Fix
Crs 205 O/A

Code

Size

ST-DH4720 180mm

Colour options: CH Chrome, GO Gold, WH White

Ideal flag hinge



Ideal Flag hinge to suit sash rebate

Code

Size

ST-HIN6114 14-25mm

Colour options: BR Brown, WH White

Butt hinges 115mm



Code

Style

ST-HIN6115 0 degree

ST-HIN6116 15 degree

Colour options: BR Brown, WH White

Letterplates



Letterplate with BLACK ABS frame

Code

Style

ST-LP4600 Aluminium 10"

ST-LP4602 Aluminium 12"

Colour options: GO Gold, SI Silver, WH White

HARDWARE

Centre striker



Adjustable centre striker with plastic packer

Code	Style
MPA3240LH	Left hand
MPA3240RH	Right hand
Colour options: CH Chrome, GO Gold, WH White	

Centre cases



Code	Style	Size
ST-MPL3113	Lockmaster PL LDB 2 Followers Centre Case only	35/92/62
ST-MPL3114	Lockmaster PL LDB 1 Followers Centre Case only	35/92
ST-MPL3151	Mila Centre Case with LDB 1 Follower	35/92
ST-MPL3213	GU Old Type Centre Case with CPB 1 Follower	35/92

Schlosser Technik sash blocker non-locking



Code
ST-SJ5171N
Colour options: BR Brown, WH White

Screws



Code	Style	Size
ST-SC39X16PDBAG	Pan Head friction stay screws	3.9x16mm
ST-SC39X25PDBAG	Countersunk Reinforced screws	3.9x25mm
ST-SC39X38CDBAG	Countersunk Reinforced screws	3.9x38mm
ST-SC43X25CGBAG	Countersunk UPVC screws	4.3x25mm
ST-SC43X40CGBAG	Countersunk UPVC screws	4.3x40mm
ST-SC48X25CGBAG	Countersunk Repair screws	4.8x25mm
ST-SC48X38CGBAG	Countersunk Repair screws	4.8x38mm

Apto cockscur handle 9mm-21mm



Code	Style	Colour
ST-WCH1801PL	Left hand	Gold
ST-WCH1801PL	Left hand	Chrome
ST-WCH1801PL	Left hand	White
ST-WCH1801PR	Right hand	Gold
ST-WCH1801PR	Right hand	Chrome
ST-WCH1801PR	Right hand	White

Colour options: GO Gold, SH Chrome, WH White

Apto cockscur wedge kit



Code	Size
ST-WCH1803	(1x2mm, 1x3mm, 1x4mm & 1x5mm)

Colour options: BL Black, WH White

Friction stay hinges with 4mm packer (pair)



Suitable to fit either 13mm or 17mm applications

Code	Style	Colour
ST-WFS5200	Top Hung Friction Stay	13mm x 8"
ST-WFS5201	Top Hung Friction Stay	13mm x 10"
ST-WFS5202	Top Hung Friction Stay	13mm x 12"
ST-WFS5203	Top & Side Hung Stay	13mm x 16"
ST-WFS5204	Top Hung Friction Stay	13mm x 20"
ST-WFS5205	Top Hung Friction Stay	13mm x 24"
ST-WFS5240	Egress Friction Stay with	10.3" x 13mm
ST-WFS5241	Egress Friction Stay with	16" x 13mm

Window espag handle (43mm)



Code	Style
ST-WEH5440-40SP	In-Line locking

Colour options: GO Gold, CH Chrome, WH White

**Concealed window restrictor
11.5mm**

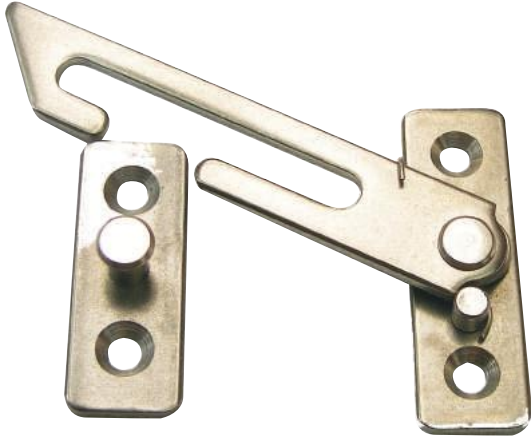

Code	Style
ST-WR5160LSIKIT-11.5	Left Hung with Stud Plate
ST-WR5160RSIKIT-11.5	Right Hung with Stud Plate

MINI cable restrictor 200mm



Code	Style
ST-WR7210	
Colour options: BR Brown, WH White	

**WE OFFER 3000+ HARDWARE PRODUCTS
AVAILABLE WITHIN 48 HOURS***

- DOOR HANDLES
- WINDOW LOCKS
- MULTI-POINT LOCKS
- CYLINDERS
- WINDOW HANDLES



For more information and to order the full range of **3000+ products** online visit

eurocell-hardware.co.uk



**3000+
PRODUCTS
INCLUDING
OBSOLETED
RANGES**



**TOP SELLERS
STOCKED IN
200+ LOCAL
BRANCHES
NATIONWIDE**



**HARDWARE
AVAILABLE
WITHIN 48*
HOURS**

*Standard lock only



**DESIGNED BY XPERTS.
FOR EXPERTS.**



SOUDAL

**Fix
ALL**

25
Years



WWW.FIXALL.CO.UK

As heard on:



We are celebrating 25 years of Fix ALL®!

Since Fix ALL® was first introduced 25 years ago, Soudal has continued to innovate and invest in developing high performance sealant and adhesive hybrid formulations. Each product within the range has its own specific characteristics, ensuring a Fix ALL solution for all your sealing and bonding needs!



SHOP ONLINE
eurocell.co.uk/shop



CALL US
08000 77 88 88



IN-BRANCH
eurocell.co.uk/
branch-finder

**FOLLOW
US ONLINE:**



**BUILDING PLASTICS
AND A WHOLE LOT MORE!**

Product specifications are subject to change without notification. Please also note that colours shown are illustrative only, as the printing process does not allow 100% accurate colours to be reproduced.

eurocell

BUILDING PLASTICS